

GIKEN

Apr.2026

GSK_N7 Controller Instruction Manual

【Target version】

Setting software version : 7 . 0 . ※※

Interface version : 1 8 9 9 - 7 . ※※※

Controller version : 1 8 5 1 - 7 . ※※

GIken Industrial Co.,Ltd

Before bigening operation



■Note

- (1)Please read this instruction manual carefully in order to ensure that you use this product correctly.
- (2)Part or all of this instruction manual may not be used or required without permission of Giken Industrial Co.,Ltd.
- (3)Please consider that handling and operation which are not described in this manual can not be performed.
And please do not do such handling or operation.
In addition, problems that occur as a result of handling and operations not described in this instruction manual are excluded from the scope of warranty.
- (4)The information in this instruction manual is subject to change without notice for improvement.
- (5)Special products may not match this specification.
Please consult separately.
- (6) Setting PC is optional.
Please contact us if necessary.



■Measures in case of emergency

If this product is in a dangerous condition, immediately turn off all power switches of the main unit or the connected equipment, or pull out all power cords from the plug outlets.
("Dangerous condition" means a condition where a fire or danger to the body is expected due to abnormal heat, smoke or fire.)



Caution

■ Cautions at first power on

- 1 . Please check that the cable connection is correct before turning on the power. (Visual check)
- 2 . Please attach a termination resistor (110 Ω) in the communication connector (COM port) of the GSK driver at the end.
- 3 . The GSK controller needs to recognize the axis number.
In the 7SEG panel, please set the axis number of 1 axis side with “d00177” and the axis number of 2 axis side with “d10177”.
(If the axis number is not set, communication from the setting PC can not be performed.)
※ When replacing the controller, it is sure to set.
- 4 . After power on, you should check the wiring using the variation of the following address values.
The torque sensor output value on the 1st axis side can be confirmed by “d00210”.
The torque sensor output value on the 2nd axis side can be confirmed with "d10210".
The current position of the encoder (resolver) on the 1st axis can be checked with "d02003".
The current position of the encoder (resolver) on the 2nd axis can be checked with "d12003".
(Electrical check)
- 5 . In order to confirm the zero point of the torque sensor, you confirm the measured value of the zero point of each axis with “d00210” and “d10210”.
In addition, it is possible to adjust the zero point by using setting software.
- 6 . After completing the above, please enter settings etc.

INDEX

1. System outline	6
2. Specifications	8
2-1 Specifications of controller	8
2-2 Basic specifications	10
2-3 Function and characteristics	15
2-4 Dimension	16
2-4-1 Interface dimensions: Standard specification • • • GSK-IF	16
2-4-2 Dimension drawing: standard specification • • • GSK-14	17
2-4-3 Dimension drawing: standard specification • • • GSK-15	18
2-4-4 Dimension drawing: standard specification • • • GSK-17	19
2-4-5 Dimension drawing: standard specification • • • GSKW-14	20
2-4-6 Dimension drawing: standard specification • • • GSKW-15	21
2-4-7 Dimension drawing: T type specification • • • GSK-T4	22
2-4-8 Dimension drawing: T type specification • • • GSK-T5 (T7)	23
2-4-9 Dimension drawing: T type specification • • • GSKW-T4	24
2-4-10 Dimension drawing: T type specification • • • GSKW-T5	25
2-4-11 Dimension drawing: Display • • • GSK-D2-N7	26
3. Wire connection	27
3-1 Connection reference drawing	27
3-1-1 GSKW System connection reference diagram	27
3-1-2 GSK System connection reference diagram	28
3-2 Used connector and mating connector	29
3-2-1 GSK Used connector and mating connector	29
3-2-2 Communication port details owned by the interface	30
3-3 External connection	31
3-3-1 External connection diagram (between GSK and NR)	31
3-3-2 External connection diagram (interface~connected device):Interface	32
3-4 Cable model list	33
3-4-1 GSK cable model list	33
3-4-2 GSKW cable model list	34
3-5 Noise countermeasure	35
3-5-1 Noise countermeasure example	35
4. Signal	36
4-1 Type of Signal	36
4-2 Type of input / output signal	37
4-2-1 Input signal	37
4-2-2 Output signal	39
4-3 Input / Output signal map	43
4-4 Selection of communication with sequencer	45
4-4-1 Type Difference by Communication Method	45
5. Operation timing chart	46
5-1 Power on and inching operation	46
5-2 Program operation - 2 step operation 1	47
5-3 Program operation - 2 step operation 2	48
5-4 Program operation - 2 step operation 3	49
5-5 Program operation - 1 step operation 1	50
5-6 Program operation - 1 step operation 2	51
5-7 Program operation - 2 step operation 4	52
5-8 Program operation - 1 step operation 3	53
5-9 Interruption of program operation (reset)	54
5-10 Operation ready OFF and Start OFF at Program operation	55
5-11 Alarm output and alarm reset during program operation	56
5-12 Tightening angle sampling operation	57
6. Setting	58
6-1 Display / setting function	58
6-1-1 About the viewpoint of the display	58
6-1-2 Setting example	59
6-1-3 Procedure of setting axis number	59
6-1-4 Procedure to erase the 7 segment display of W type unused axis	61
6-1-5 Procedure of changed tightening sampling stop torque	62
6-1-6 Procedure to change overload alarm threshold	63

6 - 2	Program configuration	66
7.	Setting function details	67
7 - 1	Fn.** display setting function list.....	67
7 - 2	(d-00***, d-10***) Driver parameter setting for each axis	68
7 - 3	SOC.T setting.....	70
7 - 4	PRE.T setting	71
7 - 5	REV.T setting.....	74
7 - 6	REA.T setting.....	76
7 - 7	Rate setting.....	82
7 - 8	X-axis rate setting	87
7 - 9	Y-axis rate setting	89
7 - 1 0	Point setting.....	90
7 - 1 1	(Fn. 0 1) Tightening result monitor of 1st axis.....	91
7 - 1 2	(Fn. 0 2) Tightening result monitor of the 2nd axis.....	91
7 - 1 3	(Fn. 0 3) Input / output monitor	93
7 - 1 4	(Fn. 0 4) Operation instruction from GSK controller.....	95
7 - 1 5	(Fn. 0 5) Unit setting.....	95
7 - 1 6	(Fn. 0 6) Interface unit setting	96
7 - 1 7	(Fn. 0 7) ID connection setting	99
7 - 1 8	About Z axis setting.....	101
7 - 1 8 - 1	Coordinate setting of Z axis.....	101
7 - 1 8 - 2	Z axis rate setting.....	102
8.	Supplementary explanation.....	103
8 - 1	Motion assist function.....	103
8 - 2	Driver function.....	103
9.	Monitor output	104
1 0.	Code Table	105
1 0 - 1	NG code list	105
1 0 - 2	Alarm Code List.....	107
1 0 - 2 - 1	Interface alarm	107
1 0 - 2 - 2	Interface alarm details.....	108
1 0 - 2 - 3	Alarm generated in the GSK driver (E**).	113
1 1.	Indication of display.....	116
1 2.	Maintenance and inspection.....	123
1 2 - 1	Notes	124
1 2 - 1 - 1	Maintenance and Inspection Precautions.....	124
1 2 - 1 - 2	Inspection items	124
1 2 - 1 - 3	lifespan	124
1 2 - 1 - 4	Capacitor	124
1 2 - 1 - 5	Relay	124
1 2 - 1 - 6	Cooling fan.....	125
1 2 - 1 - 7	Battery.....	125
1 2 - 1 - 8	E2PROM.....	125
1 2 - 2	Warranty.....	125
1 2 - 3	Tightening operation glossary.....	125
1 3.	Supplemental explanation.....	127
1 3 - 1	Precautions for wiring the Arc-Net.....	127
1 3 - 2	About GSK additional functions.....	128
1 3 - 2 - 1	Area judgment.....	128
1 3 - 2 - 2	Smooth tightening.....	128
1 3 - 2 - 3	S-shaped control.....	128
1 3 - 2 - 4	Z axis pressing control.....	128
1 3 - 3	Function to connect with EtherNet (FTP transfer)	128
1 3 - 4	SD card.....	129
1 3 - 4 - 1	AUTOMATIC STORAGE OF TIGHTENING RESULT	130
1 3 - 5	Predictive maintenance function.....	132
1 3 - 5 - 1	Outline of Predictive Maintenance	132
1 3 - 5 - 2	Flow to alarm notification.....	132
1 3 - 5 - 3	GSK controller Electronic component lifetime warning.....	133
1 3 - 5 - 4	Nut runner failure prediction warning	134
1 3 - 6	Notes on input / output communication.....	135
1 3 - 7	Precautions to read history.....	136
1 3 - 8	Items that can/cannot be set	136

1 3 - 9	About connection setting of ID controller	137
1 3 - 9 - 1	Outline.....	137
1 3 - 9 - 2	Secification of communication	137
1 3 - 9 - 3	Ressive format(PLC → Interface unit).....	137
1 3 - 9 - 4	Transmission format (Interface unit → PLC)	137
1 3 - 9 - 5	Select with condition of starting transmission.....	138
1 3 - 9 - 6	Selecting transmission data.....	138
1 3 - 1 0	About setting.....	139
1 3 - 1 0 - 1	Installation.....	139
1 3 - 1 0 - 2	standard specifications	139
1 3 - 1 0 - 3	T specification.....	139
Change log	140

1. System outline

- “GSK Nut runner System” is the torque control type nut runner system what has the function necessary to tightening of the screw and locating.
- This system has the name specified as GSK and it is classified into driver amplifier, interface unit and AC nutrunner..

Driver amplifier section

- Tightening accuracy : $3\sigma\pm 2\%$
- GSK series improved a conventional GSS series, that was realized downsized, model integration and processing speed Improvement by the capacity rise of CPU and a memory.
- The control of rotation speed and torque can be set by program, and various tightening patterns can be easily performed.
- The combination of position control and torque control enables high-speed and high-precision tightening control.
- The program No., operation status, alarm information etc. are displayed on the front panel by the self-diagnosis function.
- There are three ways to set the tightening program: setting PC, dedicated display, and input from the front panel.
- As it is equipped with automatic setting input function, even beginners can easily input settings.

Interface unit section

- An interface unit is a communication device with an external unit such as a sequencer, display, setting PC, or printer.
- By connecting a personal computer to the interface unit, the GSK system can check information related to tightening control such as setting data and tightening results.
- By connecting a printer, you can check data such as settings and tightening results without connecting it to a PC.
- The communication setting can correspond to both specifications of parallel IO and serial IO.
- One interface unit is always required for each system.
(Use one interface unit for every 16 axes if there is a positioning unit, 30 axes for none.)

AC Nut runner section

- As with the conventional GSS series, ANZM-type nutrunners can be used continuously.

<Specification of nut runner>

Nutrunner model	MAX. tightening torque (N.m)	MAX. rotational Speed (rpm)	Power supply current (A rms)	Moter model	Weight (Kg)	Transducer model
ANZM-50	4.5	1750	0.6	TS4603N1920E203	1.0	AZM-100
ANZM-250	20	310	0.6	TS4603N1920E203	1.6	AZM-350
ANZM-350	30	430	1.2	TS4617N1920E203	1.9	AZM-350
ANZM-500	45	310	1.2	TS4617N1920E203	1.9	AZM-500
ANZM-850	80	420	2.3	TS4609N1920E203	3.9	AZM-850
ANZM-1600	140	420	4.5	TS4618N1922E203 (TS4618N1920E203)	5.0	AZM-1500
ANZM-1800S	160	420	4.5	TS4618N1922E203 (TS4618N1920E203)	5.0	AZM-2000
ANZM-2000	180	290	4.5	TS4618N1922E203 (TS4618N1920E203)	6.8	AZM-2500
ANZM-3000	280	235	8.5	TS4619N1920E203	9.0	AZM-4000
ANZM-3500	330	200	4.5	TS4618N1922E203 (TS4618N1920E203)	10.0	AZM-4000
ANZM-5000	470	250	8.5	TS4619N1926E207 (TS4619N1922E207)	10.5	AZM-7500
ANZM-7000	650	175	8.5	TS4619N1926E207 (TS4619N1922E207)	10.5	AZM-7500
ANZM-9000	650	175	8.5	TS4619N1926E207 (TS4619N1922E207)	14.5	AZM-12000
ANZM-9000S	850	130	8.5	TS4619N1926E207 (TS4619N1922E207)	13.9	AZM-12000S

The maximum tightening torque is the output value at a speed of 20 rpm.

(The dimensions etc. of the nutrunner are published in the catalog etc. Please inquire for details)

2. Specifications

2-1 Specifications of controller

Composition	IF unit	Standard type (M-NET) CC-link DeviceNet EtherNet/IP PROFINET I/O
	Controller unit	Single standard type 3 kinds, Single T type 3 kinds, 2 axis standard type 2kinds, 2 axis T type 2kinds
	Display	Tightening Result (Torque and time and angle and judge) Axial array Setting data Displays do not affect operation even if not used
Data	Setting PC	USB communication
	I/F ⇔ Controller Controller ⇔ Controller	Arc-Net
	DATA control (PC)	RS422, SD card
	DATA saving	Tightening data: about 5000 cases When IF is connected, It can output from a PC. SD card
	Printer connection	It connects a PC. (setting software is required for output)
	Max axis number for connection	30 axis control (software-based 60 axis)
Controller Display	DATA display	6-digit 7SEG.LED
	Extraordinary display	AL code indicate + NG code indicate
Setting	Setting input method	Personal computer and the controller front panel, display panel
	Memory backup	E2PROM, FRAM
	Setting value backup	PC⇒FD,HD
Outside dimensions	IF unit	44×226×91
	Controller unit GSK-14/GSKW-14 GSK-T4/GSKW-T4	44×226×171.6
	Controller unit GSK-15	86.5×226×171.6
	Controller unit GSK-17	116.5×226×171.6
	Controller unit GSKW-15	160.5×226×171.6
	Controller unit GSK-T5/GSK-T7	65.5×226×211.6
	Controller unit GSKW-T5	109.5×226×211.6

	Display GSK-D2-N7	182.5×138.8×45.8 Please install by considering the projection of the connector
Tightening setting	Axis number	• 30 axis x 16 program x 220 step
	Program number	• 30 axis x 50 program x 70 step
	Step number	• 8 axis x 50 program x 220 step Maximum values are different depending on the combination
	Setting items	T:Rating 30kinds H:REA.T SET, K:PRE.T SET, G:REV.T SET S:SCC.T SET,screw number setting Each 50kinds
Tightening method	Torque method, time and angle monitor	"Zone Monitoring" function exists
	Angle method, time monitor	"Gradient judgment" function exists
Tightening control	Sequencing tightening (Blocktightening)	MAX. 17blocks (70 steps) MAX. 55blocks (220 steps)
	Retry	Whether or not set for each program
	Baking determination	Reverse torque, judgement of area size
	Reverse rotation for fixed quantity	Time and angle
	Speed switching	4 stage, angle management and continuously variable transmission (smoothing) function
Accuracy	Torque waveform	Disply,all axis indication or personal computer
	Angle stop accuracy	within +0.5° (downward 30rpm)
	Angle display minimum unit	0.1°
	Tightening accuracy	downward 3σ±2%
Connection	Connection cable	Standard type and T-tyap: connectingmethod
Control power	Rated current	GSK-IF-N1 : 0.2A GSK-14/GSK-T4 : 0.2A GSKW-14/GSKW-T4- : 0.2A GSK-15/GSK-T5 : 0.3A GSKW-15/GSKW-T5 : 0.4A GSK-17/GSK-T7 : 0.3A
	Inrush current at startup	GSK-IF-N1 : 5.0A GSK-14/GSK-T4 : 5.0A GSKW-14/GSKW-T4- : 5.0A GSK-15/GSK-T5 : 5.0A GSKW-15/GSKW-T5 : 5.0A GSK-17/GSK-T7 : 5.0A
Others	Zero-point adjustment	Automatic correction (Tolerance range setting is provided.)
	Axis cutting function	Can be connected from a personal computer or the controller front panel.
	Communication with other unit	Arc-Net
	Setting input	USB Communication
	Communication with PLC	SIO (M-NET, CC-Link, and etc) or PIO
	Display connection	Connected to IF unit

2-2 Basic specifications

I/F model	GSK-IF-N7 : M-NET (Standard) GSK-IFCC-N7 : CC-Link GSK-IFDN-N7 : Devie-NET GSK-IFET-N7 : EtherNet/IP GSK-IFPNIO-N7 : PROFINET I/O GSK-IFSG-N7 : Parallel I/O (Input/output: 24 points each) GSK-IFSG2-N7 : Parallel I/O (Input/output: 48 points each)					
Standard specification model (GSK)	GSK-14-E-N7		GSK-15-E-N7		GSK-17-E-N7	
Standard specification model (GSKW)	GSKW-14-E-N7		GSKW-15-E-N7		/	
T specification model (GSK)	GSK-T4-E-N7		GSK-T5-E-N7		GSK-T7-E-N7	
T specification model (GSKW)	GSKW-T4-E-N7		GSKW-T5-E-N7		/	
Control power input	DC24 V \pm 10% (21.6~26.4V)					
Drive power input	3-phase AC220V \pm 20% (176~264V) 50/60 Hz					
Withstand voltage	AC 1500 V for 1 minute					
Insulation resistance	DC 500 V 10M Ω more					
Controller Calorific value	Controller 1 unit : 15W					
Momentary power failure	No effect in the range less than 50 msec (excluding the driving time)					
Nut runner model	ANZM-50 ANZM-250	ANZM-350 ANZM-500	ANZM-850	ANZM-1600 ANZM-1800S ANZM-2000 ANZM-3500	ANZM-3000	ANZM-5000 ANZM-7000 ANZM-9000 ANZM-9000S
Applicable motor	TS4603N1920 E203	TS4617N1920 E203	TS4609N1920 E230	TS4618N1922 E203	TS4619N1920 E203	TS4619N1926 E203
Motor output W	75	150	300	600	1125	1125
Rotor inertia kgm ²	0.04x10 ⁻⁴	0.083x10 ⁻⁴	0.38x10 ⁻⁴	0.79x10 ⁻⁴	2.62x10 ⁻⁴	2.62x10 ⁻⁴
Driving power supply rated electrical capacity Arms	0.6	1.2	2.3	4.5	8.5	8.5
Rating output current A rms	1.0	1.9	3.6	6.8	7.1	11.0
Instantaneous maximum current Arms	5.4	10.7	19.6	38.6	40.2	62.9

Rating torque N.m	0.159	0.318	0.64	1.27	2.39	2.39
Instantaneous max. torque N.m	0.95	1.91	3.82	7.64	14.32	14.32
Maximum rotation number without loads rpm	12500				7500	12500
Motor drive system	Transistor PWM sine wave drive					
Angle sensor	Incremental encoder (With the zero magnification signal, line driver output, 256C/T)					
Operating temperature and humidity	0 to 50°C, Less than 90%RH (No condensation)					

※About combination of controllers and NRs other than ANZM series

The combination of each NR and controller is shown below.

• **ANZM series**

Nut runner model	Driving power supply rated electrical capacity (Arms)	Adaptive Controller Standard model	Adaptive Controller T model
ANZM-12000	8.5	GSK-17-E-N7	GSK-T7-E-N7
ANZM-15000	27.0	GSK-17-E1-N7	GSK-T7-E1-N7
ANZM-20000			
ANZM-28000			

• **ANZMC series**

Nut runner model	Driving power supply rated electrical capacity (Arms)	Adaptive Controller Standard model	Adaptive Controller T model
ANZMC-30	0.6	GSK-14-E-N7 GSKW-14-E-N7	GSK-T4-E-N7 GSKW-T4-E-N7
ANZMC-40SFFT-E3	0.8	GSK-14-E3-N7 GSKW-14-E3-N7	GSK-T4-E3-N7 GSKW-T4-E3-N7
ANZMC-50	0.6	GSK-14-E-N7 GSKW-14-E-N7	GSK-T4-E-N7 GSKW-T4-E-N7
ANZMC-250			
ANZMC-350	1.2	GSK-14-E-N7 GSKW-14-E-N7	GSK-T4-E-N7 GSKW-T4-E-N7
ANZMC-500			
ANZMC-850	2.3	GSK-15-E-N7 GSKW-15-E-N7	GSK-T5-E-N7 GSKW-T5-E-N7
ANZMC-1600	4.5		
ANZMC-1800S			
ANZMC-2000			
ANZMC-3000	8.5		
ANZMC-3500	4.5	GSK-17-E-N7	GSK-T7-E-N7
ANZMC-5000	8.5		
ANZMC-7000			
ANZMC--9000			
ANZMC-9000S			
ANZMC-12000	27.0	GSK-17-E1-N7	GSK-T7-E1-N7
ANZMC-15000			
ANZMC-20000			
ANZMC-28000			

• **ANZMH series**

Nut runner model	Driving power supply rated electrical capacity (Arms)	Adaptive Controller Standard model	Adaptive Controller T model
ANZMH-200	1.2	GSK-14-E-N7	GSK-T4-E-N7
ANZMH-450	2.3	GSKW-14-E-N7	GSKW-T4-E-N7
ANZMH-900	4.5	GSK-15-E-N7 GSKW-15-E-N7	GSK-T5-E-N7 GSKW-T5-E-N7
ANZMH-1500	8.5	GSK-17-E-N7	GSK-T7-E-N7
ANZMH-1550			
ANZMH-1850S			
ANZMH-2000			
ANZMH-2001			
ANZMH-9000	37.5	GSK-17-E1-N7	GSK-T7-E1-N7

• **ANZMCH series**

Nut runner model	Driving power supply rated electrical capacity (Arms)	Adaptive Controller Standard model	Adaptive Controller T model
ANZMCH-200	1.2	GSK-14-E-N7	GSK-T4-E-N7
ANZMCH-450	2.3	GSKW-14-E-N7	GSKW-T4-E-N7
ANZMCH-900	4.5	GSK-15-E-N7 GSKW-15-E-N7	GSK-T5-E-N7 GSKW-T5-E-N7
ANZMCH-1500	8.5	GSK-17-E-N7	GSK-T7-E-N7
ANZMCH-1550			
ANZMCH-1850S			
ANZMCH-2000			
ANZMCH-2001			
ANZMCH-2500			

• **ANZMSH series**

Nut runner model	Driving power supply rated electrical capacity (Arms)	Adaptive Controller Standard model	Adaptive Controller T model
ANZMSH-120E2	1.2	GSK-14-E2-N7 GSKW-14-E2-N7	GSK-T4-E2-N7 GSKW-T4-E2-N7
ANZMSH-130	2.3	GSK-14-E-N7 GSKW-14-E-N7	GSK-T4-E-N7 GSKW-T4-E-N7
ANZMSH-150E2	1.2	GSK-14-E2-N7 GSKW-14-E2-N7	GSK-T4-E2-N7 GSKW-T4-E2-N7
ANZMSH-500	2.3	GSK-14-E-N7 GSKW-14-E-N7	GSK-T4-E-N7 GSKW-T4-E-N7
ANZMSH-700			
ANZMSH-2000	8.5	GSK-17-E-N7	GSK-T7-E-N7
ANZMSH-2001			

• **ANZMKH series**

Nut runner model	Driving power supply rated electrical capacity (Arms)	Adaptive Controller Standard model	Adaptive Controller T model
ANZKHM-400	4.5	GSK-15-E-N7 GSKW-15-E-N7	GSK-T5-E-N7 GSKW-T5-E-N7
ANZKHM-700			

• **ANCKHM series**

Nut runner model	Driving power supply rated electrical capacity (Arms)	Adaptive Controller Standard model	Adaptive Controller T model
ANCKHM-200	3.0	GSK-14-E1-N7	GSK-T4-E1-N7
ANCKHM-300	4.5	GSKW-14-E1-N7	GSKW-T4-E1-N7
ANCKHM-500	7.2	GSK-15-E1-N7 GSKW-15-E1-N7	GSK-T5-E1-N7 GSKW-T5-E1-N7

• **ANZMCTH series**

Nut runner model	Driving power supply rated electrical capacity (Arms)	Adaptive Controller Standard model	Adaptive Controller T model
ANZMCTH-100E1	1.2	GSK-14-E1-N7 GSKW-14-E1-N7	GSK-T4-E1-N7 GSKW-T4-E1-N7
ANZMCTH-150E1	2.3		
ANZMCTH-230E1			
ANZMCTH-450E1	4.5	GSK-15-E1-N7 GSKW-15-E1-N7	GSK-T5-E1-N7 GSKW-T5-E1-N7
ANZMCTH-700E1			
ANZMCTH-900E1			

• **ANZMCXH series**

Nut runner model	Driving power supply rated electrical capacity (Arms)	Adaptive Controller Standard model	Adaptive Controller T model
ANZMCXH-100E1	1.2	GSK-14-E1-N7 GSKW-14-E1-N7	GSK-T4-E1-N7 GSKW-T4-E1-N7
ANZMCXH-150E1	2.3		
ANZMCXH-230E1			
ANZMCXH-450E1	4.5	GSK-15-E1-N7 GSKW-15-E1-N7	GSK-T5-E1-N7 GSKW-T5-E1-N7
ANZMCXH-700E1			
ANZMCXH-900E1			

• **ANZR series**

Nut runner model	Driving power supply rated electrical capacity (Arms)	Adaptive Controller Standard model	Adaptive Controller T model
ANZR-1600	4.5	GSK-15-R-N7 GSKW-15-R-N7	GSK-T5-R-N7 GSKW-T5-R-N7
ANZR-2000			
ANZR-3500			
ANZR-5000	8.5	GSK-17-R-N7	GSK-T7-R-N7
ANZR-7000			
ANZR-9000			
ANZR-9000S			
ANZR-12000			

• **ANZRC series**

Nut runner model	Driving power supply rated electrical capacity (Arms)	Adaptive Controller Standard model	Adaptive Controller T model
ANZRC-1600	4.5	GSK-15-R-N7 GSKW-15-R-N7	GSK-T5-R-N7 GSKW-T5-R-N7
ANZRC-2000			
ANZRC-3500			
ANZRC-5000	8.5	GSK-17-R-N7	GSK-T7-R-N7
ANZRC-7000			
ANZRC-9000			
ANZRC-9000S			
ANZRC-12000			

• **ANZMRCH series**

Nut runner model	Driving power supply rated electrical capacity (Arms)	Adaptive Controller Standard model	Adaptive Controller T model
ANZMRCH-2000	8.5	GSK-17-R-N7	GSK-T7-R-N7
ANZMRCH-2001			
ANZMECH-2500			

• **LUR series**

Nut runner model	Driving power supply rated electrical capacity (Arms)	Adaptive Controller Standard model	Adaptive Controller T model
LUR-1000	5.7	GSK-15-E-L7	GSK-T5-E-L7

• **Positioning motor (With battery type)**

Motor type	Motor Output (W)	brake	keyway	Driving power supply rated electrical capacity (Arms)	Adaptive Controller
TS4603N2058E200	100	×	×	0.8	GSK-14 (T4) -E-P7B GSKW-14 (T4) -E-P7B
TS4603N2099E200		○	○		
TS4603N7060E200		○	×		
TS4603N7066E200		○	○		
TS4604N2021E200	150	×	×	1.2	
TS4604N2023E200		○	○		
TS4604N7021E200		○	×		
TS4604N7023E200		○	○		
TS4607N2088E200	200	×	×	1.5	
TS4607N2085E200		○	○		
TS4609N2085E200	400	×	×	3.0	
TS4609N2120E200		○	○		
TS4609N7049E200		○	×		
TS4609N7084E200		○	○		

• **Positioning motor (Battery-less type)**

Motor type	Motor Output (W)	brake	keyway	Driving power supply rated electrical capacity (Arms)	Adaptive Controller
TSM4104N2820E205	100	×	○	0.8	GSK-14 (T4) -E-P7 GSKW-14 (T4) -E-P7
TSM4104N7820E205		○			
TS4604N2820E200	150	×		1.2	
TS4604N7820E200		○			
TSM4254N2820E200	400	×		3.0	
TSM4204N7820E205		○			
TSM4354N2802E200	750	×		5.7	
TSM4354N7802E200		○			

2-3 Function and characteristics

The protected function		Over current, over load, over speed, encoder failure, drive power failure, E2PROM failure and CPU failure, etc.
display	7SEGMENT LED	Alarm No., NG information Program No., Block No. Operation monitor Tightening result (Torque, etc.)
Parameter settings		Set the following parameters by a personal computer and input them to the IF unit. . Program 16 or 50 . Rating 30 . PRE.T . REA.T . REV.T . SOC.T } Each 50
Memory of tightening data		Tightening data: About 5,000 per axis Alarm history: 16 per axis Tightening waveform: 1 per axis It is possible to check the data from PC.
Multi-axis compatible		1 to 30 units of controller or 1 to 15 units of double type controller can be connected to 1 Interface unit. Max. 30 axes multiaxial control is possible.
Communication with sequencer		Communication according to many types of compatible standards using Anybus ※ Please refer to 2-2 about corresponding standard
Axis disabling function		It can be set by the operation of the PC setting or the front panel (Use at the time of failure, etc.) ※ It can not be used when using positioning.
Zero magnification check function		Failure diagnosis function of torque sensor (This is performed at each tightening.)
Gear check function		Gear and motor shaft burn-in diagnostic function (selectable with or without)
Simulation movement		Simulation operation is possible from a PC. (Tightening seating angle sampling start)
Calendar function		It stores year, month, day, hour, minute and second for each data.
Regenerative function (Overvoltage detection)		When the drive voltage exceeds a certain value, the built in regenerative circuit is consumed by the internal resistance.
Discharge function		If it is a single, it is a natural discharge function that uses the top of the front panel, and if it is a W type, the LED at the top and bottom right of the panel.
Standard inertia		$J_L \leq 30J_M$
Rotating direction		Make CCW in the positive direction seen from the motor shaft end
Analog monitor		2 points ± 8 V (outputs torque, speed and current to the check terminal on the panel surface)

2-4 Dimension

2-4-1 Interface dimensions: Standard specification...GSK-IF

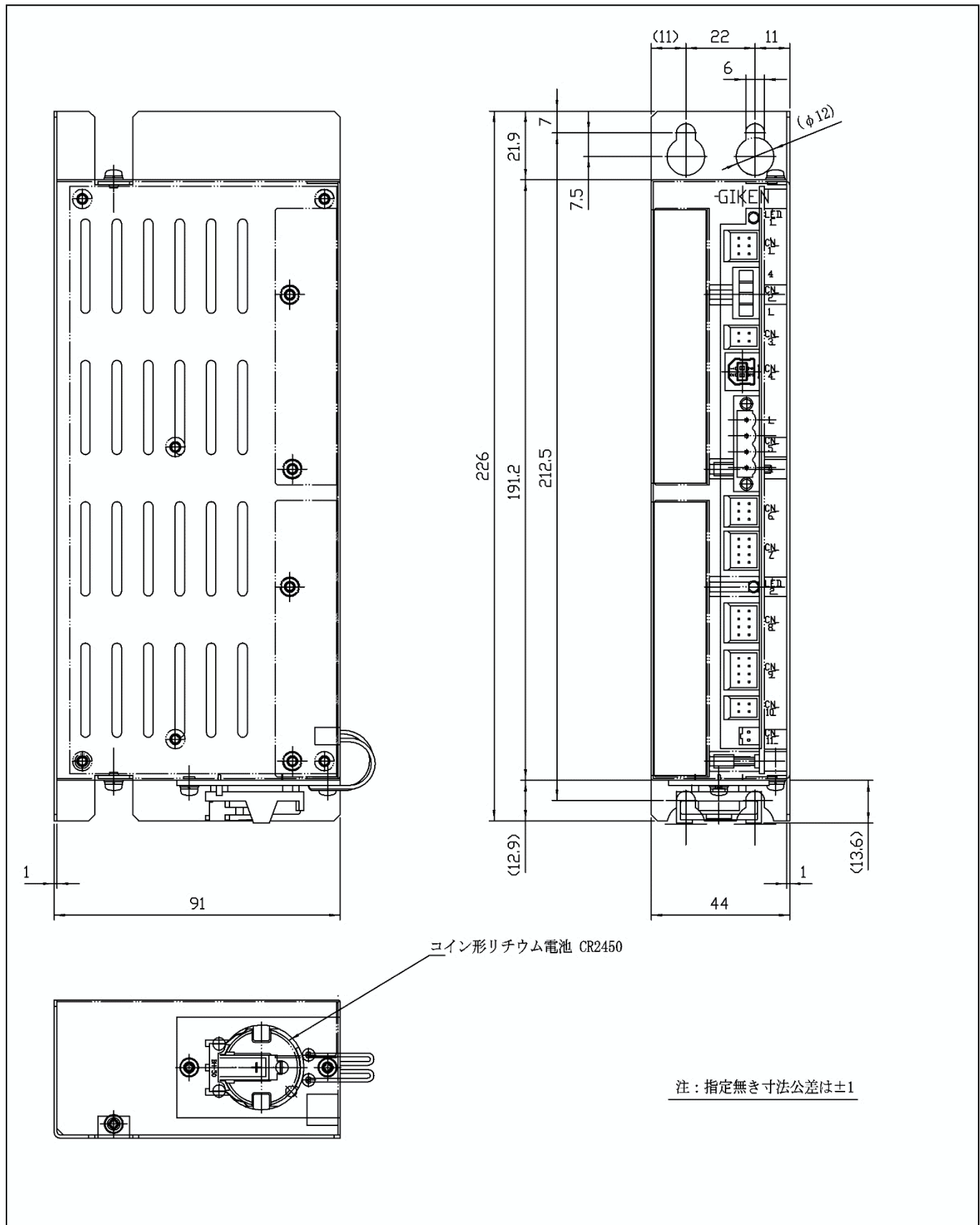

2-4-2 Dimension drawing: standard specification...GSK-14

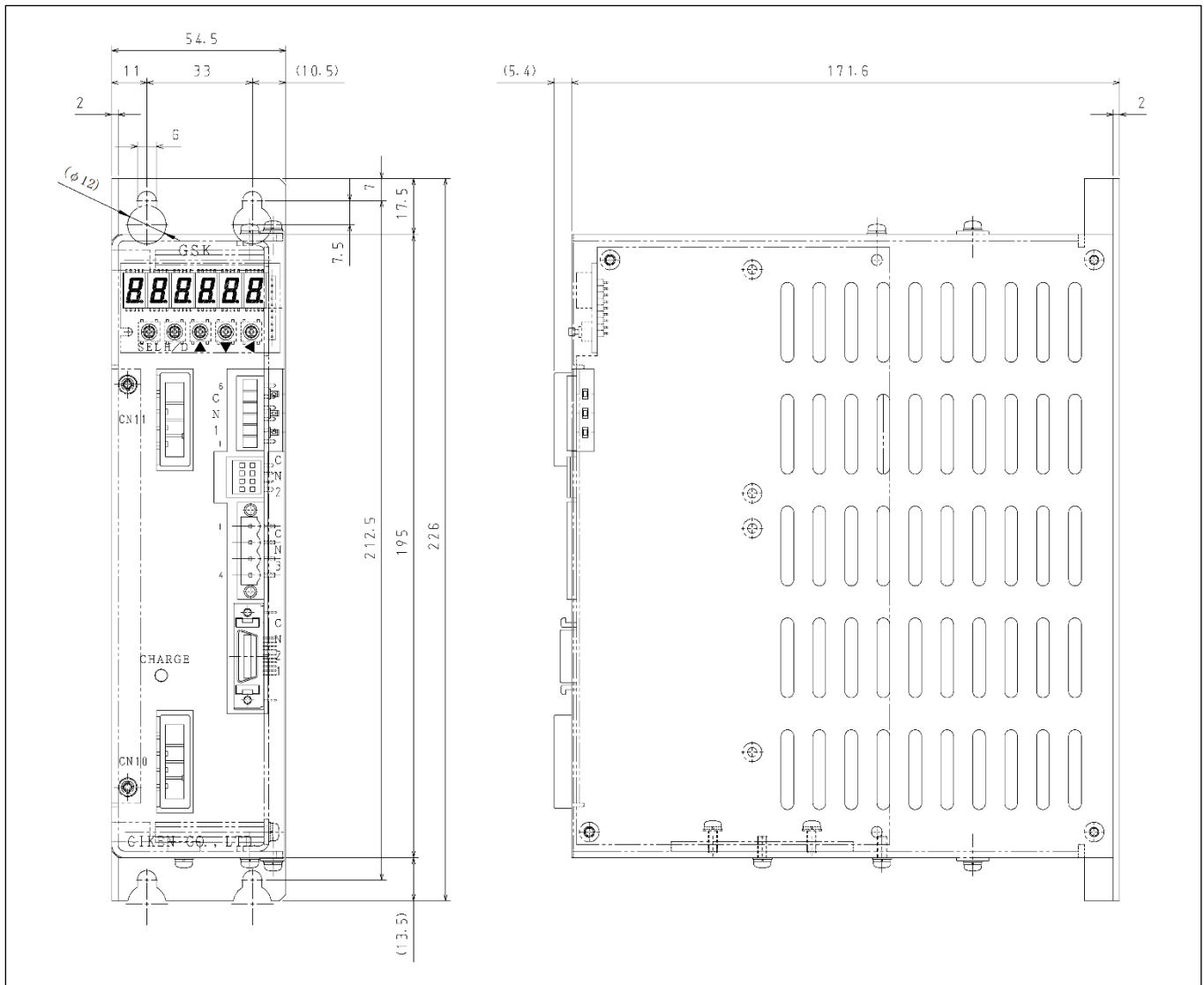

2-4-3 Dimension drawing: standard specification...GSK-15

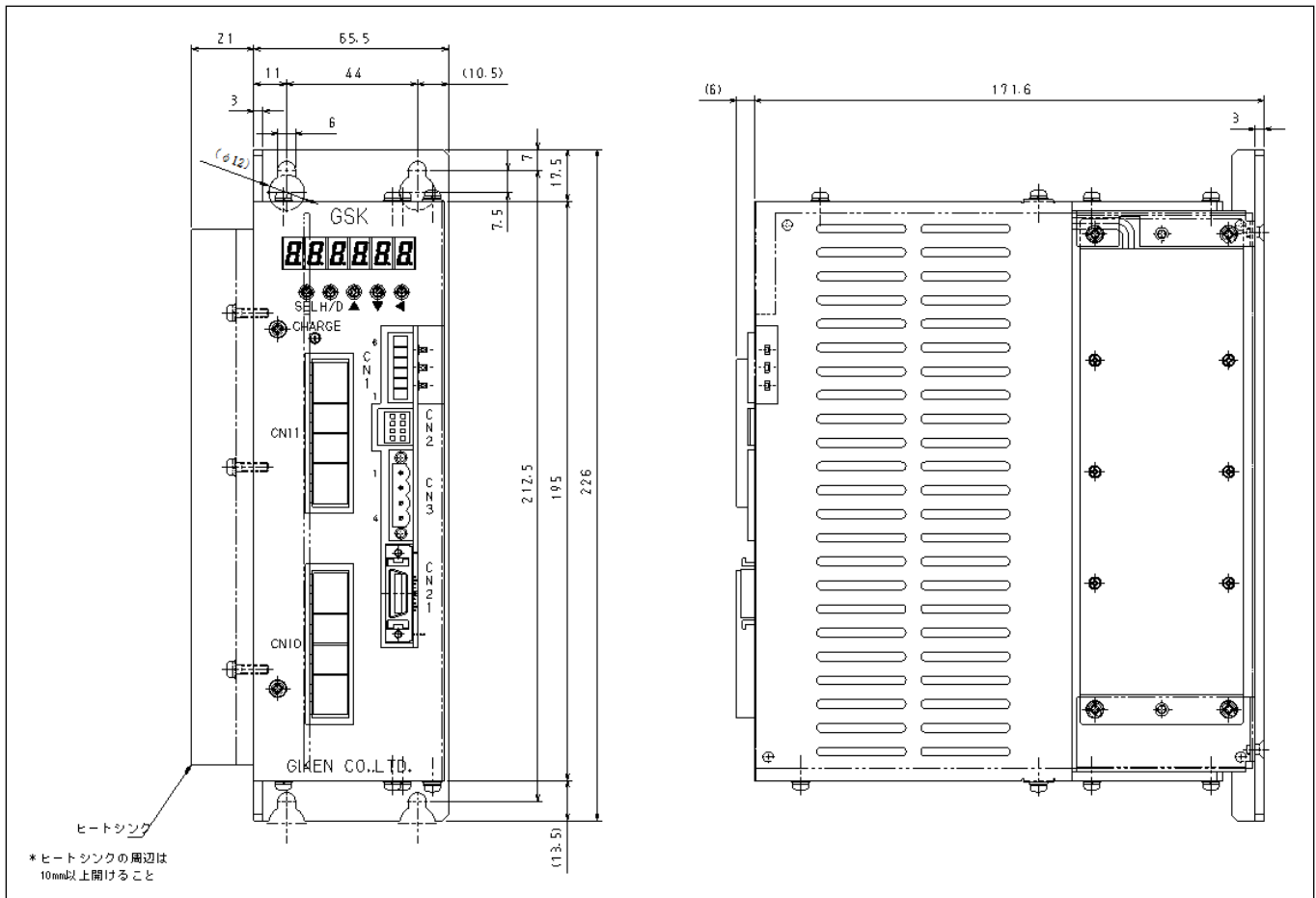

2-4-4 Dimension drawing: standard specification...GSK-17

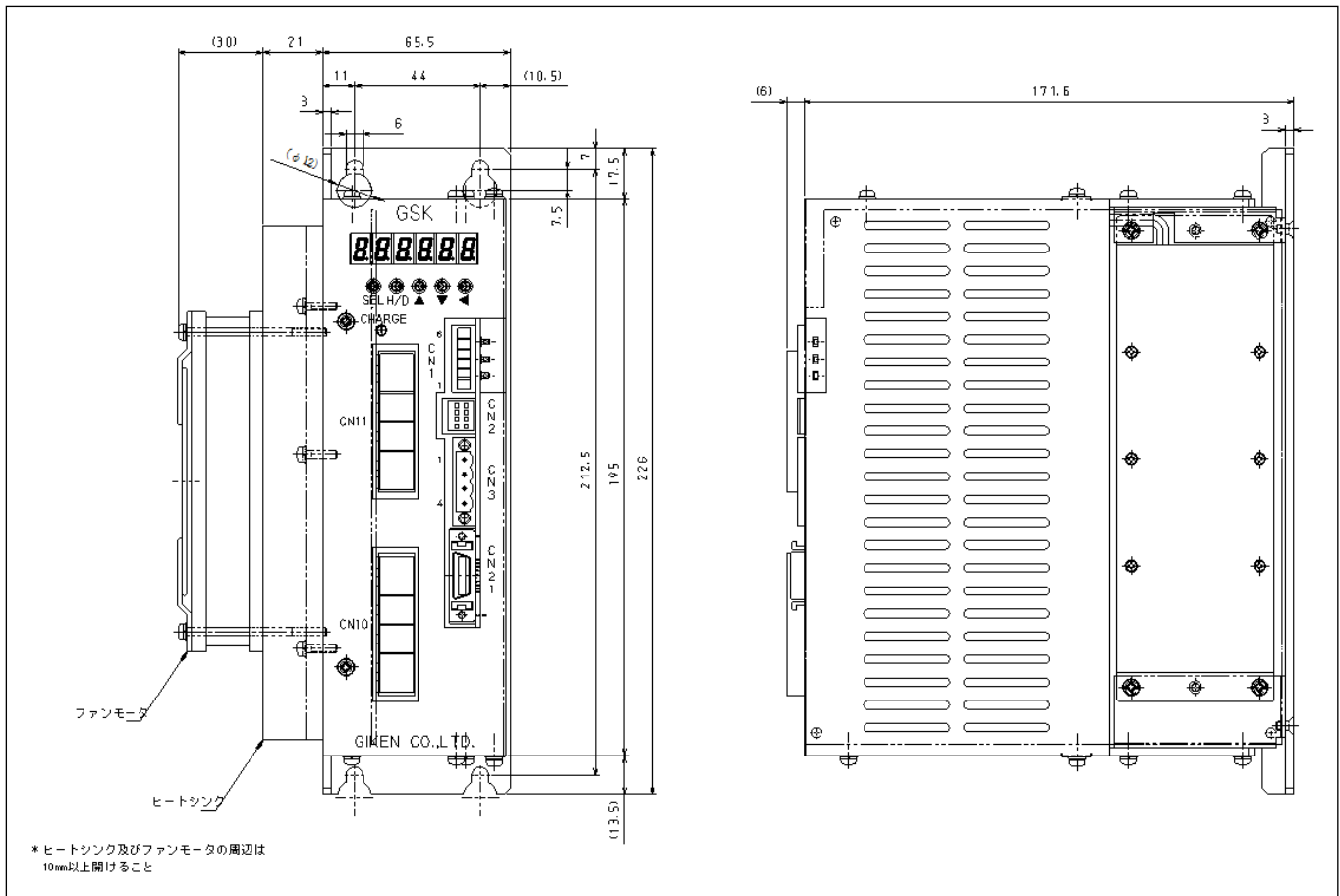

2-4-6 Dimension drawing: standard specification...GSKW-15

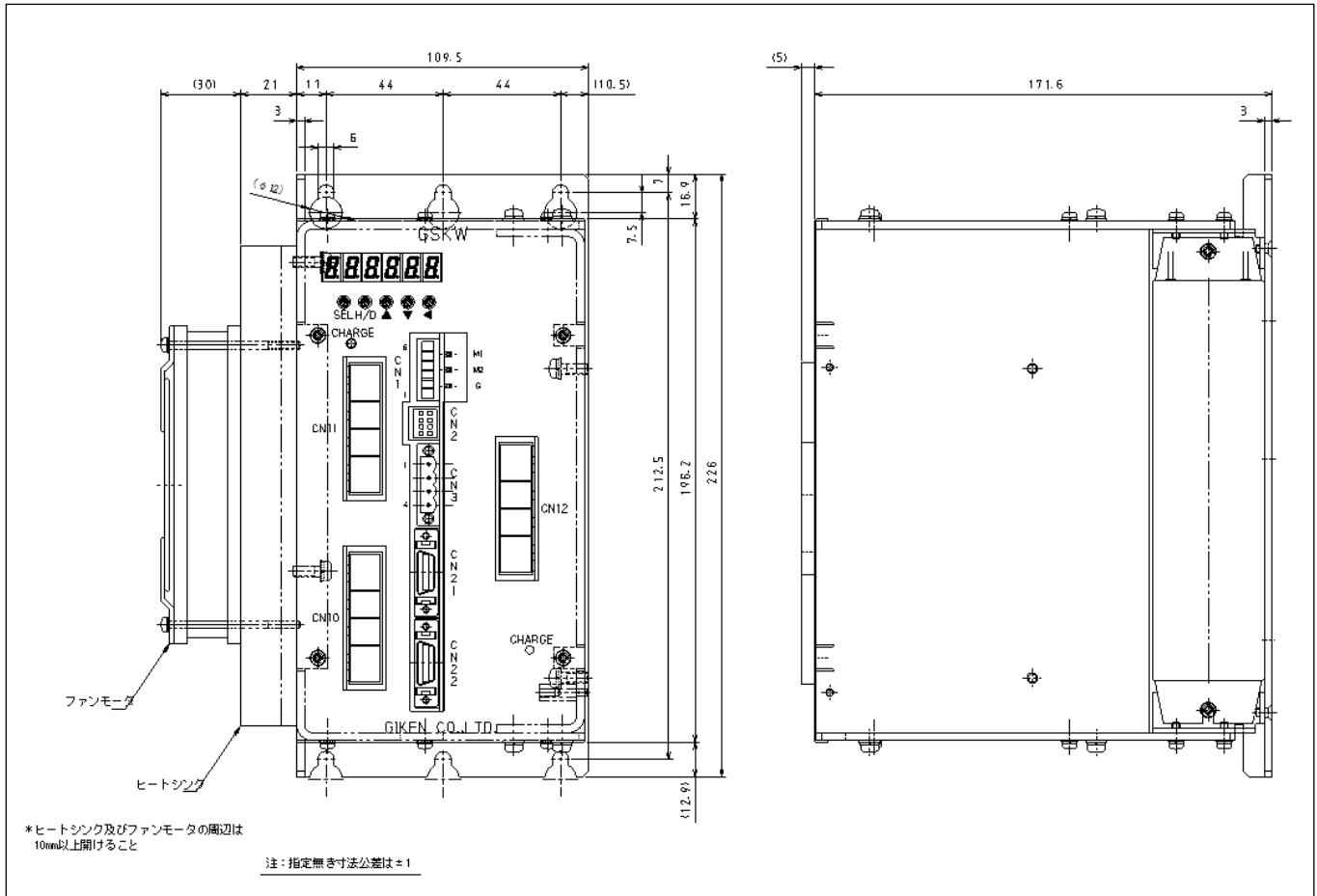

2-4-7 Dimension drawing: T type specification •••GSK-T4

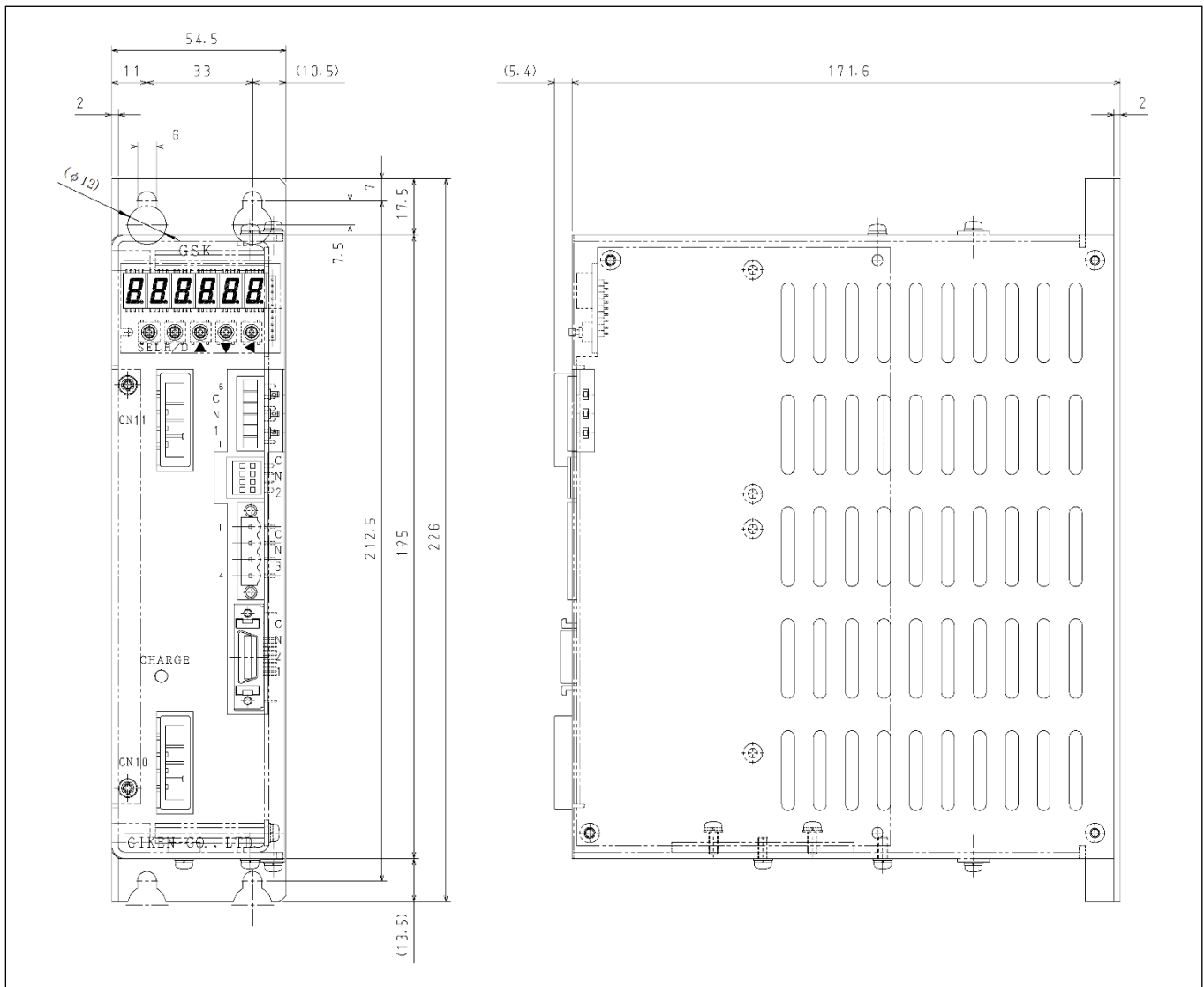

2-4-8 Dimension drawing: T type specification...GSK-T5 (T7)

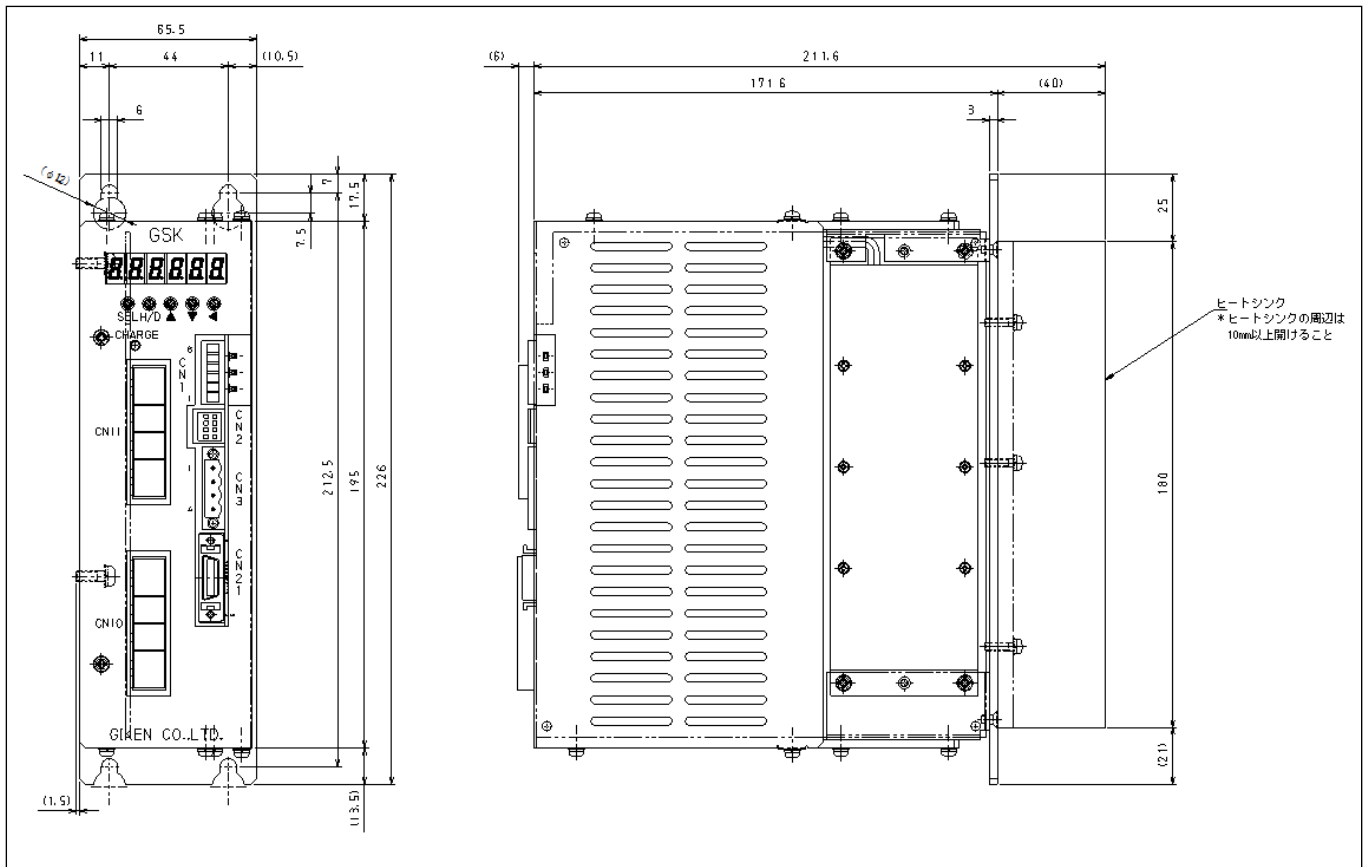

2-4-9 Dimension drawing: T type specification•••GSKW-T4

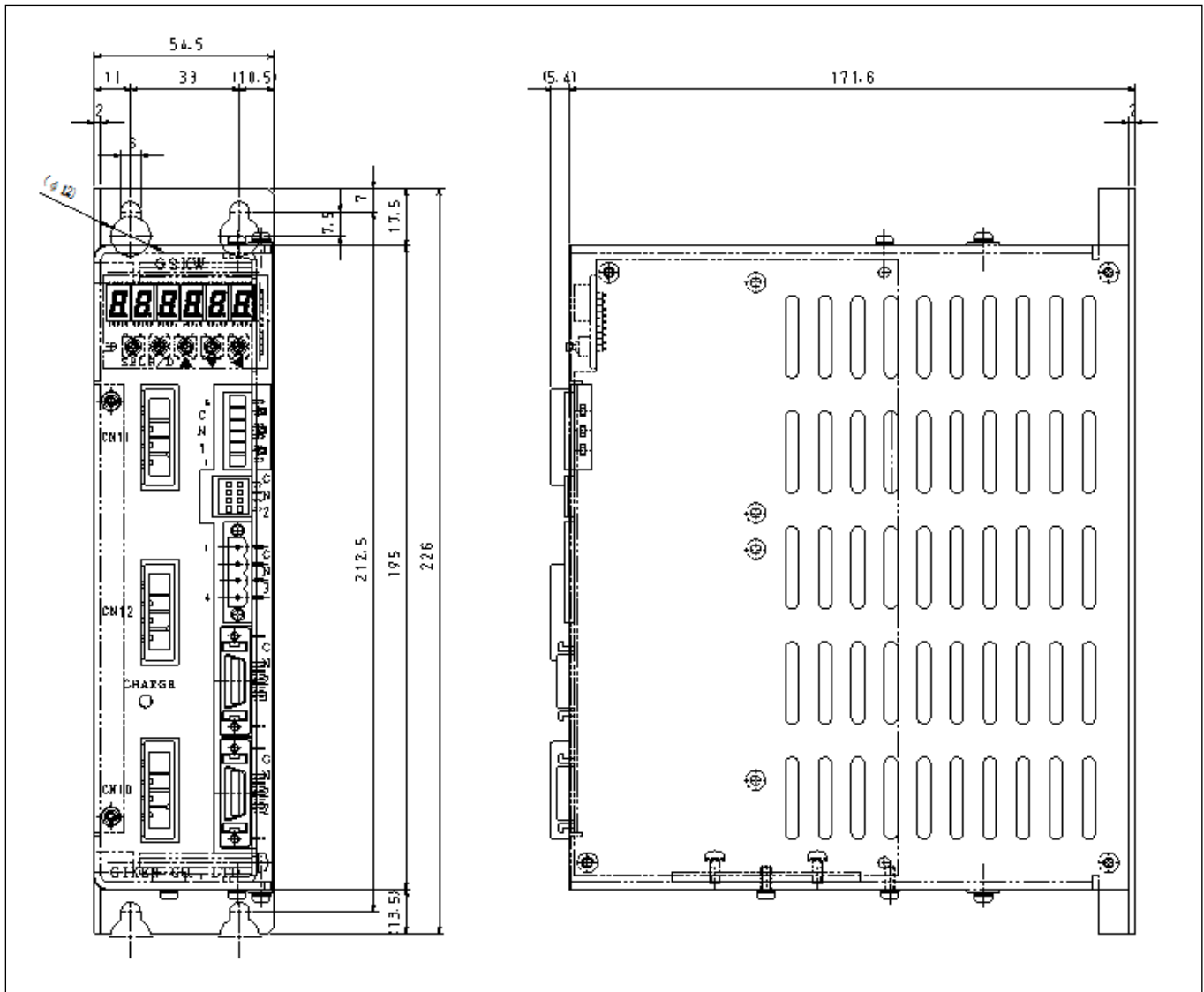

2-4-10 Dimension drawing: T type specification...GSKW-T5

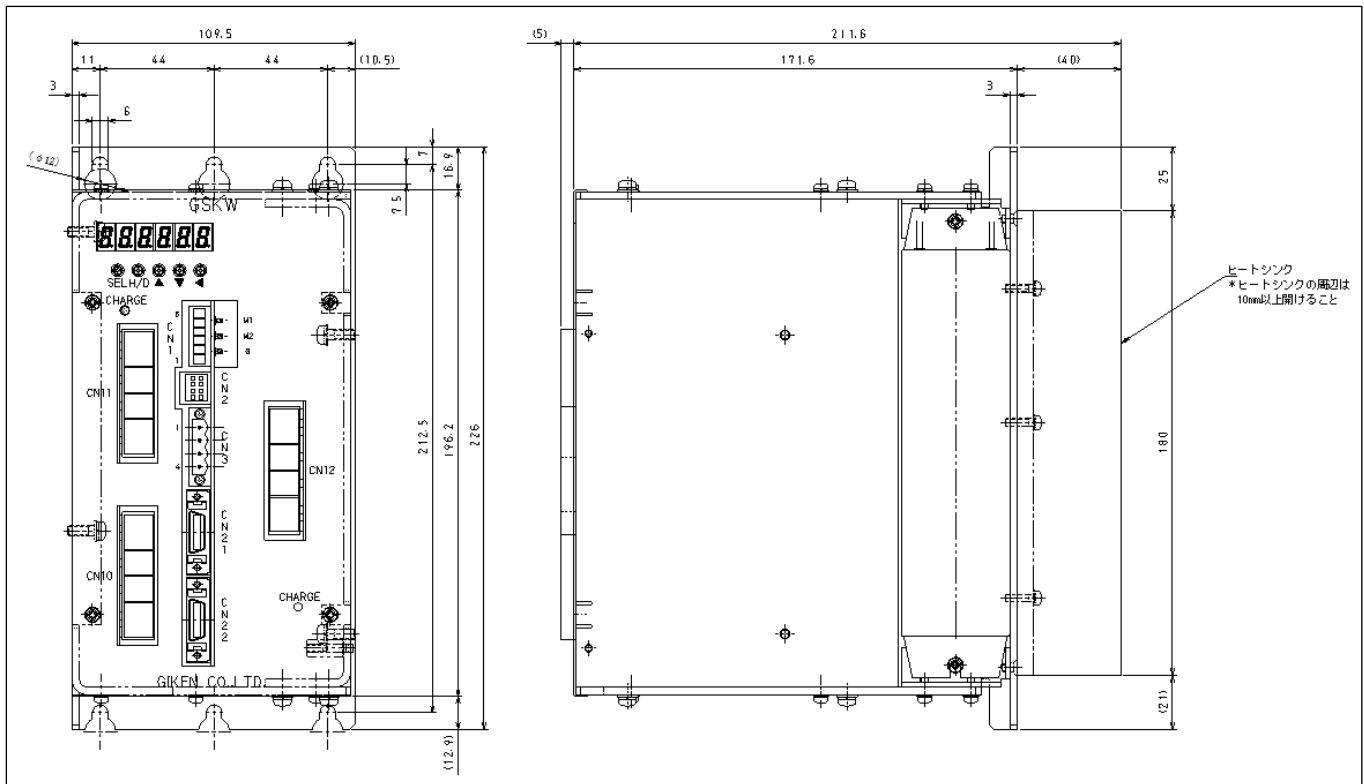

2-4-11 Dimension drawing: Display...GSK-D2-N7

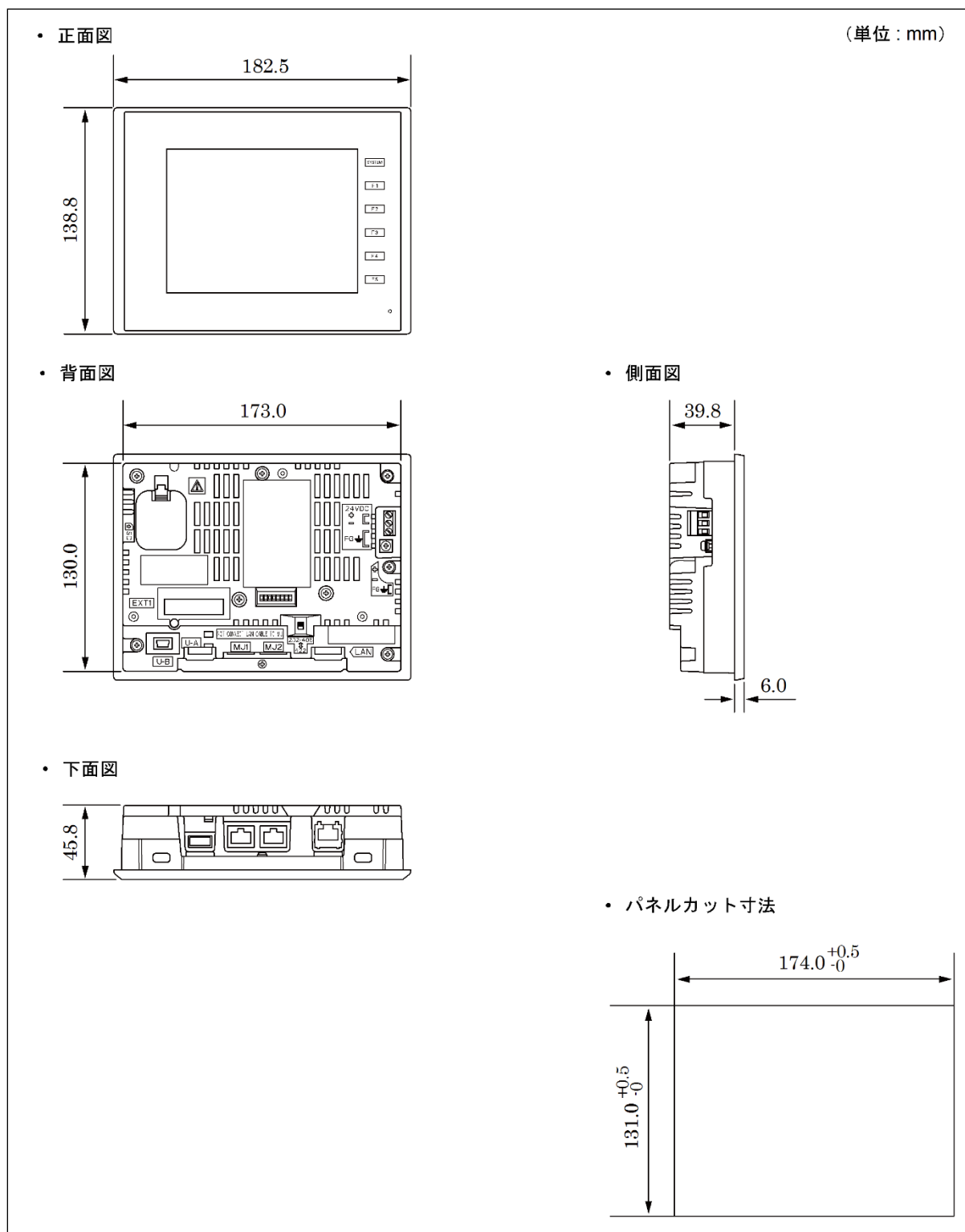

3. Wire connection

3-1 Connection reference drawing

3-1-1 GSKW System connection reference diagram

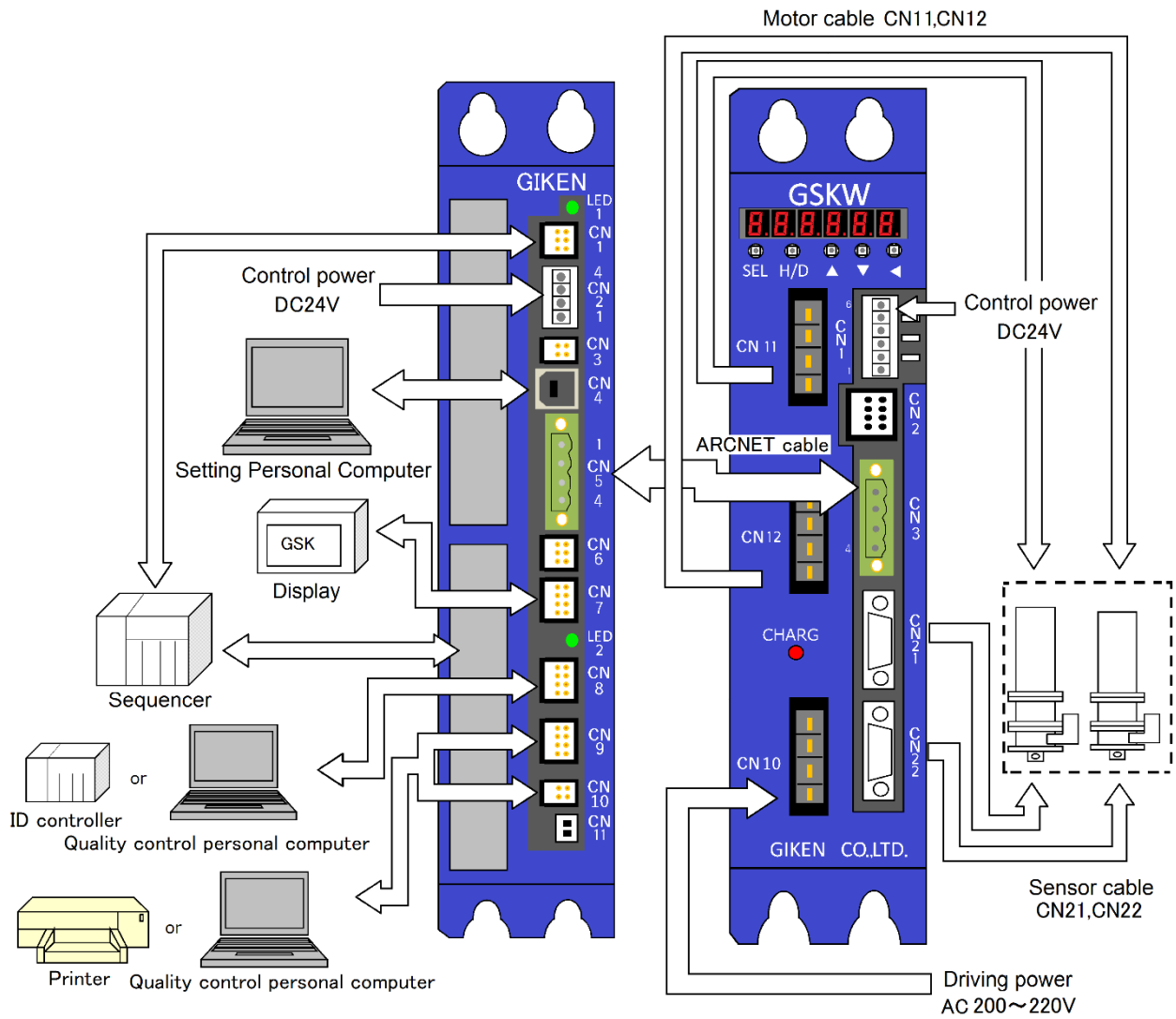

3-1-2 GSK System connection reference diagram

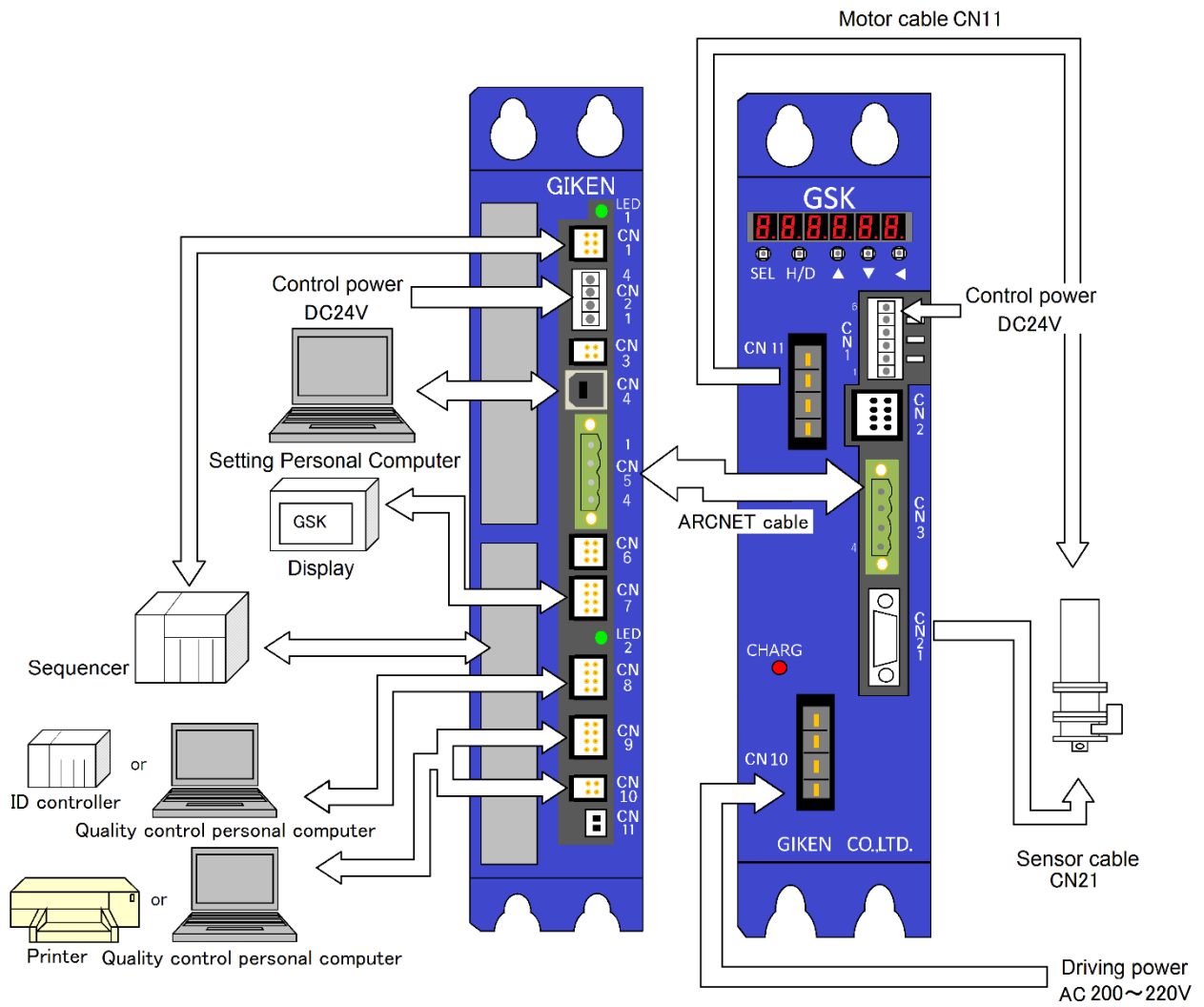

3-2 Used connector and mating connector

3-2-1 GSK Used connector and mating connector

• GSK driver unit (14/T4)

Port No.	Use/Matter	Used model	Matching model	Matching model pin	annexed
CN1	For the control power supply connection	734-166 (WAGO)	734-106 (WAGO)	—	○
CN2	Not used	1-1827864-4 (TYCO)	1-1827864-4 (TYCO)	1827570-2 (TYCO)	—
CN3	For communication among controllers at ARCNET	MSTB2,5/6-STF-5,08 (PHOENIX CONTACT)	MSTB2,5/6-STF-5,08 (PHOENIX CONTACT)	—	○
CN10	For the driving power supply connection	2-179277-2 (TYCO)	2-178128-4 (TYCO)	1-353717-2 (TYCO)	○
CN11	For power line of nutrunner 1	1-179277-2 (TYCO)	1-178128-4 (TYCO)	1-175218-2 (TYCO)	—
CN12	For power line of nutrunner 2	1-179277-2 (TYCO)	1-178128-4 (TYCO)	1-175218-2 (TYCO)	—
CN21	For sensor line of nutrunner1	10220-52A2PL (3MJapan)	10320-52A0-008 (3MJapan)	10120-3000VE (3MJapan)	—
CN22	For sensor line of nutrunner2	10220-52A2PL (3MJapan)	10320-52A0-008 (3MJapan)	10120-3000VE (3MJapan)	—

CN12/CN22 exists only for GSKW controllers

• GSK driver unit (15/T5, 17/T7)

Port No.	Use/Matter	Used model	Matching model	Matching model pin	annexed
CN1	For the control power supply connection	734-166 (WAGO)	734-106 (WAGO)	—	○
CN2	Not used	1-1827876-4 (TYCO)	1-1827864-4 (TYCO)	1827570-2 (TYCO)	—
CN3	For communication among controllers at ARCNET	MSTB2,5/6-STF-5,08 (PHOENIX CONTACT)	MSTB2,5/6-STF-5,08 (PHOENIX CONTACT)	—	○
CN10	For the driving power supply connection	1-917541-2 (TYCO)	1-179958-4 (TYCO)	316040-2 (TYCO)	○
CN11	For power line of nutrunner 1	2-917541-2 (TYCO)	2-179958-4 (TYCO)	316040-2 (TYCO)	—
CN12	For power line of nutrunner 2	2-917541-2 (TYCO)	2-179958-4 (TYCO)	316040-2 (TYCO)	—
CN21	For sensor line of nutrunner1	10220-52A2PL (3MJapan)	10320-52A0-008 (3MJapan)	10120-3000VE (3MJapan)	—
CN22	For sensor line of nutrunner2	10220-52A2PL (3MJapan)	10320-52A0-008 (3MJapan)	10120-3000VE (3MJapan)	—

CN12/CN22 exists only for GSKW controllers

• GSK Interface unit

Port No.	Name	Used connector type	Matching connector housing	Matching connector pin	annexed
CN1	PLC connection port	1-1827876-3 (TYCO)	1-1827864-3 (TYCO)	1827570-2 (TYCO)	—
CN2	Control power supply input port	734-144 (WAGO)	734-104 (WAGO)	—	○
CN3	Not used	1-1827876-2 (TYCO)	1-1827864-2 (TYCO)	1827570-2 (TYCO)	—
CN4	Port for setting PC connection	UBB-4R-D14T-4D (JST)	USB Type B	—	—
CN5	Controller connection port	MSTB2.5/4-GF-5.08 (PHOENIX CONTACT)	MSTB2.5/4-STF-5.08 (PHOENIX CONTACT)	—	○
CN6	Port for CAN communication	1-1827876-3 (TYCO)	1-1827864-3 (TYCO)	1827570-2 (TYCO)	—
CN7	Display connection port	1-1827876-4 (TYCO)	1-1827864-4 (TYCO)	1827570-2 (TYCO)	—
CN8	Port for ID controller connection	1-1827876-4 (TYCO)	1-1827864-4 (TYCO)	1827570-2 (TYCO)	—
CN10	Printer connection port	1-1827876-2 (TYCO)	1-1827864-2 (TYCO)	1827570-2 (TYCO)	—

3-2-2 Communication port details owned by the interface

• GSK Interface unit

Port No.	Name	Explanation
CN1	PLC (RS485)	This is used when communicating with PLC in M-NET. ※ Not used for other communications.
CN2	Power / READY notification(SW)	4-core connector Left 2 cores are power supply (24V) Right two-wire start notification for relay
CN3	Not used	Not used
CN4	A setting personal computer (USB)	This is used to rewrite and read data using setting software.
CN5	Driver (Arc-Net)	When connecting some GSK controllers, this port connects the controllers with Arc-Net.
CN6	CAN communication connector	Not used※
CN7	External display (RS422)	This is used for a connection with the external display.
CN8	ID controller or quality control PC (RS422)	ID controller and a printer are selected either by the setting of a personal computer. It can not be connected at the same time. The connection partner of quality control personal computer depends on the setting. ID controller when using ⇒ ⑨ ⑩ · Printer when using ⇒ ⑧ 【Caution】 Please do not connect the equipment at the same time in two connectors of CN9 and CN10.
CN9	Printer or personal computer for quality control (CN9: RS422)	
CN10	Printer or personal computer for quality control (CN10: RS232C)	
CN11	Battery back up	A backup battery for clocks is connected here.

※Unused CN6 may be used for special specification.

3-3 External connection

3-3-1 External connection diagram (between GSK and NR)

: Driver amplifier of standard specification and T specification

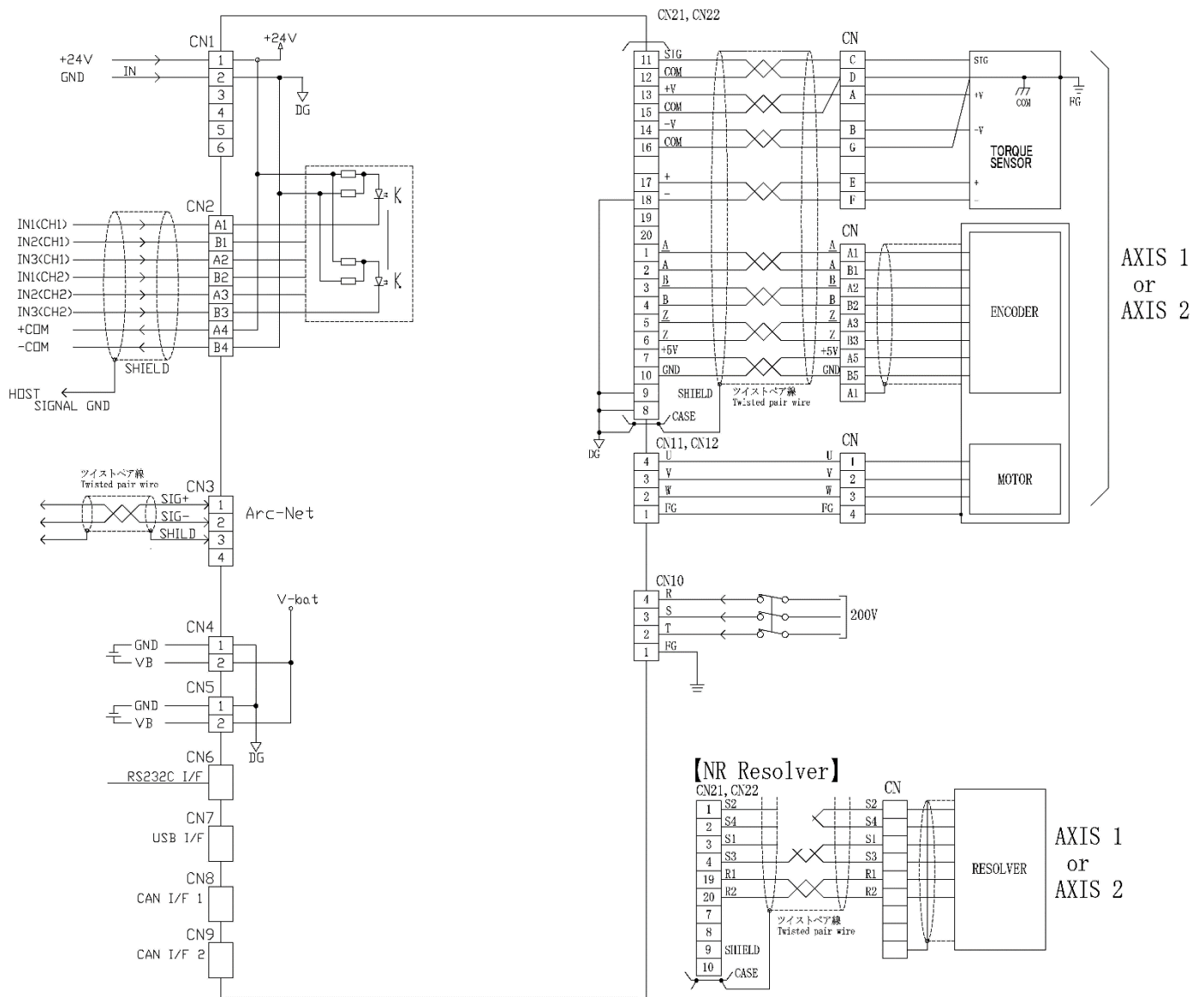

3-3-2 External connection diagram (interface~connected device):Interface

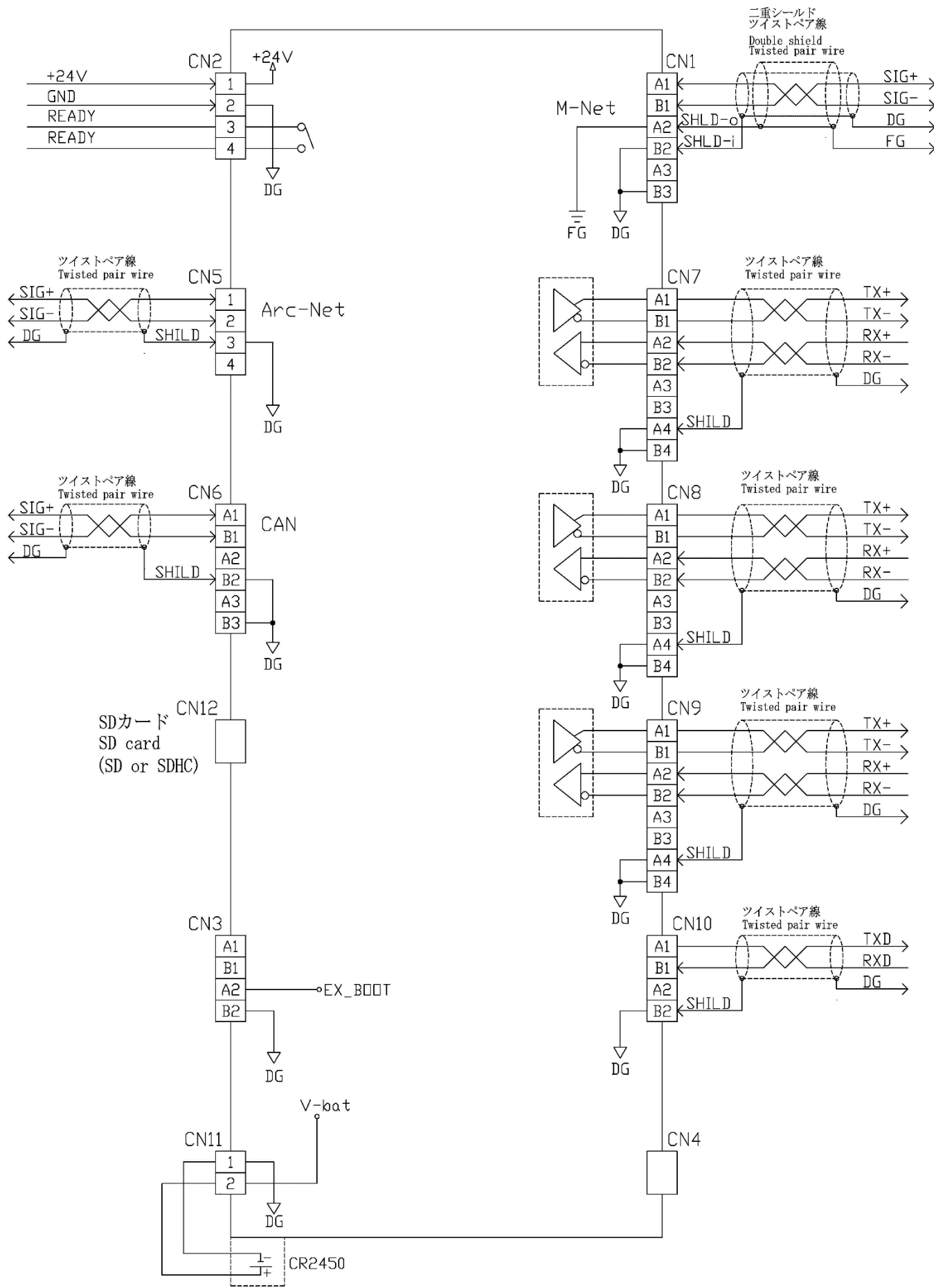

3-4 Cable model list

3-4-1 GSK cable model list

Cable name	NR that can use the cable	Cable model
Motor direct cable (NR~Driver)※1	ANZM-50~ANZM-850 etc	K8M5DW-4R-□M
	ANZM-1600~ANZM-3500 etc	K8M30D-4R-□M
	ANZM-5000~ANZM-9000 etc	K8M90D-4R-□M
Motor relay movable cable (NR~Relay section)	ANZM-50~ANZM-850 etc	K8M5TW-4R-□M
	ANZM-1600~ANZM-3500 etc	K8M30T-4R-□M
	ANZM-5000~ANZM-9000 etc	K8M90T-4R-□M
Motor relay fixed cable (Relay section~Driver)※1	ANZM-50~ANZM-850 etc	K8M5TW-4A-□M
	ANZM-1600~ANZM-3500 etc	K8M30T-4A-□M
	ANZM-5000~ANZM-9000 etc	K8M90T-4A-□M
Encoder·Sensor direct cable (NR~Driver)	ANZM-50~ANZM-9000 etc	K8E*S*D-16R-□M
	ANZMC, ANZMCH, ANZMSH etc Small torque sensor series	K8E*S*DC-16R-□M
Resolver·Sensor direct cable (NR~Driver)	ANZR series	K8R*S*D-16R-□M
	ANZRC series	K8R*S*DC-16R-□M
Encoder·Sensor relay movable cable (NR~Relay section)	ANZM-50~ANZM-9000 etc	K8E*S*T-16R-□M
	ANZMC, ANZMCH, ANZMSH etc Small torque sensor series	K8E*S*TC-16R-□M
Resolver·Sensor relay movable cable (NR~Relay section)	ANZR series etc	K8R*S*T-16R-□M
	ANZRC series etc	K8R*S*TC-16R-□M
Encoder·Sensor relay fixed cable (Relay section~Driver)	ANZM-50~ANZM-9000 etc	K8E*S*T-16A-□M
	ANZMC, ANZMCH, ANZMSH etc Small torque sensor series	K8E*S*TC-16A-□M
Resolver·Sensor relay fixed cable (Relay section~Driver)	ANZR series etc	K8R*S*T-16A-□M
	ANZRC series etc	K8R*S*TC-16A-□M
Encoder·Sensor extension cable (Relay section~Relay section)	—	K8EST-16EX-□M
Resolver·Sensor extension cable (Relay section~Relay section)	—	K8RST-16EX-□M

※1. Ferrite core MRFC-8 (manufactured by Kitagawa Kogyo) is attached to the UVW wire for the motor cable.
The above ferrite core is recommended when manufactured.

3-4-2 GSKW cable model list

Cable name	NR that can use the cable	Cable model
Motor direct cable (NR~Driver)※1	ANZM-50~ANZM-850 etc	K8M5DW-4R-□M
	ANZM-1600~ANZM-3500 etc	K8M30D-4R-□M
Motor relay movable cable (NR~Relay section)	ANZM-50~ANZM-850 etc	K8M5TW-4R□M
	ANZM-1600~ANZM-3500 etc	K8M30T-4R-□M
Motor relay fixed cable (Relay section~Driver)※1	ANZM-50~ANZM-850 etc	K8M5TW-4A□M
	ANZM-1600~ANZM-3500 etc	K8M30T-4A-□M
Encoder・Sensor direct cable (NR~Driver)	ANZM-50~ANZM-3500 etc	K8E*S*D-16R-□M
	ANZMC, ANZMCH, ANZMSH etc Small torque sensor series	K8E*S*DC-16R-□M
Resolver・Sensor direct cable (NR~Driver)	ANZR series	K8R*S*D-16R-□M
	ANZRC series	K8R*S*DC-16R-□M
Encoder・Sensor relay movable cable (NR~Relay section)	ANZM-50~ANZM-3500 etc	K8E*S*T-16R-□M
	ANZMC, ANZMCH, ANZMSH etc Small torque sensor series	K8E*S*TC-16R-□M
Resolver・Sensor relay movable cable (NR~Relay section)	ANZR series etc	K8R*S*T-16R-□M
	ANZRC series etc	K8R*S*TC-16R-□M
Encoder・Sensor relay fixed cable (Relay section~Driver)	ANZM-50~ANZM-3500 etc	K8E*S*T-16A-□M
	ANZMC, ANZMCH, ANZMSH etc Small torque sensor series	K8E*S*TC-16A-□M
Resolver・Sensor relay fixed cable (Relay section~Driver)	ANZR series etc	K8R*S*T-16A-□M
	ANZRC series etc	K8R*S*TC-16A-□M

Note 1 (All cables)

he inside of □ represents the cable length in meters.

Please choose from 3m, 7m, 10m, 15m and 20m.

It's also possible to manufacture some cables of other than above, but in that case more time is required.

Note 2 (Encoder(Resolver)・sensor cable)

E *: If the encoder cable length from the junction is not filled in, we will create it as standard. (0.3 m)

S *: If the sensor cable length from the junction is not filled in, we will create it as a standard. (1.5 m)

※1. Ferrite core MRFC-8 (manufactured by Kitagawa Kogyo) is attached to the UVW wire for the motor cable.
The above ferrite core is recommended when manufactured.

3-5 Noise countermeasure

3-5-1 Noise countermeasure example

Attach the ferrite core for noise suppression to the controller side of the cable.
For the positioning GSK encoder cable, attach it to the encoder side of the cable.

【INTERFACE】

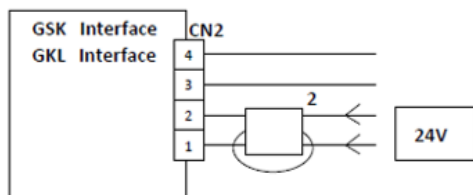

【NUTRUNNER CONTROLLER】

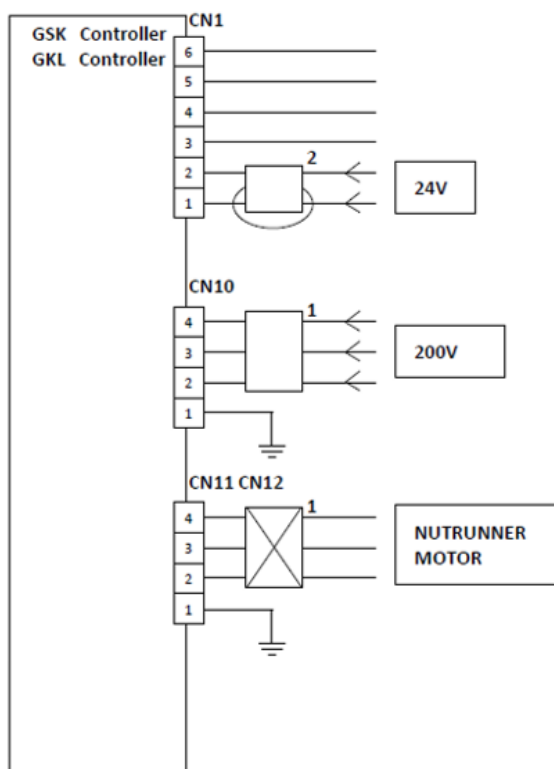

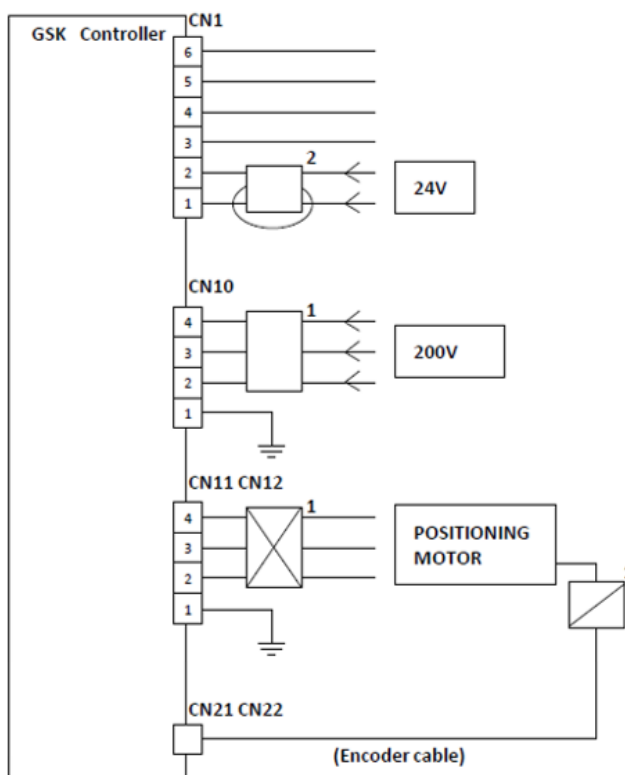

【POSITIONING CONTROLLER】





Recommended countermeasure parts

 :フェライトコア GRFC-9 北川工業製
:Ferrite core GRFC-9 KITAGAWA INDUSTRIES CO.,LTD.

 :フェライトコア MRFC-8 北川工業製
:Ferrite core MRFC-8 KITAGAWA INDUSTRIES CO.,LTD.

 :フェライトコア E04SR200935A 星和電機製
:Ferrite core E04SR200935A SEIWA INDUSTRIES CO.,LTD.

 :フェライトコア 1ターン
:Ferrite core 1turn

 :フェライトコア 2ターン
:Ferrite core 2turn

4. Signal

4-1 Type of Signal

Parallel I/O

I/O	Points	Name	Specification	Contents
Parallel input signal	48 points	IN1~IN48	DC24V 11mA	GSK-IFSG-N7 : Input/output: 24 points each GSK-IFSG2-N7 : Input/output: 48 points each
Parallel output signal	48 points	OUT1~OUT48	DC24V 30mA max	

Serial I/O

I/O	Note	Using
Arc-Net	It is necessary to install a 110Ω termination resistor.	Communication between controllers in multi-axis control
CC-LINK	Model : GSK-IFCC-N7	Communication of tightening management with PLC
Devise-NET	Model : GSK-IFDN-N7	Communication of tightening management with PLC
EtherNet/IP	Model : GSK-IFDN-N7	Communication of tightening management with PLC
PROFINET I/O	Model : GSK-IFPNIO-N7	Communication of tightening management with PLC

Analog monitor

	Contents
M1	Torque, current, and speed data output via panel operation For details, see Section 9 Monitor Output
M2	

※The above can be changed by the operation of the setting panel.

Interface unit

I/O	Points	Using
RS232C	1 point	Parameters and other various data are input / output by PC connection
Centronics or RS422	1 point /2 points	Parallel printer connection ID and product PC connection (impossible simultaneously with the printer)
RS422	1 point	Connect with a display
RS485	1 point	Connect with sequencer etc. in SIO format (option)

4-2 Type of input / output signal

4-2-1 Input signal

Input("PLC" ⇒ "GSK")

No.	Bit	I/O	Name	Contents													
0	0	IN 1	Operation ready	<p>It is an operation preparation command to the GSK system.</p> <p>OFF: Operation prohibited. GSK-IF does not work.</p> <ul style="list-style-type: none"> Start signal is not accepted. GSK performs emergency stop if this signal becomes OFF during operation <p>ON: The operation is permitted.</p> <ul style="list-style-type: none"> When GSK can operate, the output signal "Operation ready completed" becomes ON. 													
0	1	IN 2	AUTO/MANU	<p>This signal selects automatic operation / manual operation.</p> <p>OFF: You can start the following manual operation.</p> <table border="1"> <tr> <td>Input signal</td> <td>Operation</td> </tr> <tr> <td>Inching start</td> <td>Inching start</td> </tr> <tr> <td>JOG start</td> <td>Move to specified position</td> </tr> <tr> <td>XJOG/YJOG</td> <td>XY jog operation</td> </tr> </table> <p>【In the positioning mode】 In addition to the above, automatic operation in block units is possible. It is necessary to be in this state when teaching.</p> <p>ON: Automatic operation (program operation) can be started.</p> <table border="1"> <tr> <td>Input signal</td> <td>Operation</td> </tr> <tr> <td rowspan="2">Start</td> <td>【In the multi axis mode】 It works only one block. It will wait for the next start when finished.</td> </tr> <tr> <td>【In the positioning mode】 It will perform the block operation continuously.</td> </tr> </table>	Input signal	Operation	Inching start	Inching start	JOG start	Move to specified position	XJOG/YJOG	XY jog operation	Input signal	Operation	Start	【In the multi axis mode】 It works only one block. It will wait for the next start when finished.	【In the positioning mode】 It will perform the block operation continuously.
Input signal	Operation																
Inching start	Inching start																
JOG start	Move to specified position																
XJOG/YJOG	XY jog operation																
Input signal	Operation																
Start	【In the multi axis mode】 It works only one block. It will wait for the next start when finished.																
	【In the positioning mode】 It will perform the block operation continuously.																
0	2	IN 3	Start	<p>Automatic operation of the program is started at the OFF⇒ON rising edge of this signal.</p> <p>You must keep this signal at ON during operation.</p> <p>If it changes to 0 during operation, it will stop the cycle and pause automatic operation.</p>													
0	3	IN 4	Inching start	<p>The nutrunner performs inching operation at the OFF⇒ON rising edge of this signal.</p>													
0	4	IN 5	Determination reset	<p>The judgment result of automatic operation is reset at the OFF⇒ON rising edge of this signal.</p> <p>When the program operation is completed, it is accepted if the output signal "total judgment OK" or "total judgment NG" is on</p>													
0	5	IN 6	Alarm reset	<p>The OFF⇒ON rising edge of this signal clears the GSK system alarm status.</p> <p>When the alarm reset is successful, the operation ready complete signal will return to ON if the operation preparation signal is ON.</p>													
0	6	IN 7	QL input	<p>The QL procedure is executed on the OFF⇒ON rising edge of this signal.</p>													
0	7	IN 8	QL mode	<p>This sets whether to accept QL signal.</p> <p>OFF: Disabled ON: Enabled</p> <p>This signal must be ON when performing QL operation.</p>													
1	0-5	IN 9-14	Program bit1 ~ Program bit6	<p>They specify the program number in automatic operation. (The program number is 6 bit data which regarded "Program bit 1" as LSB)</p> <p>The program number is specified in the range from 1 to the maximum selected value.</p>													
1	6	IN 15	—	—													
1	7	IN 16	GSK reset	<p>At the rising edge of OFF to ON, it resets the GSK system to its initial state.</p>													

2	0-3	IN 17-20	X JOG + X JOG - YJOG + Y JOG -	【Positioning mode only】 It performs jog operation on X and Y axes respectively.
2	4-5	IN 21-22	INX 1 INX 2	【Positioning mode only】 This signal is used to suspend X-axis movement in automatic operation.
2	6-7	IN 23-24	INY 1 INY 2	【Positioning mode only】 This signal is used to suspend Y-axis movement in automatic operation.
3	0-1	IN 25-26	Cylinder1 returned Cylinder1 advanced	【Positioning mode only】 This signal is used to refer to the vertical position of the nut runner.
3	2-3	IN 27-28	X return signal Y return signal	【Positioning mode only】 The input of this signal moves the X and Y axes to the return position. If it is in operation such as automatic operation, it will stop operation and then start moving.
3	4-5	IN 29-30	WAIT 1 WAIT 2	【Positioning mode only】 This signal temporarily pauses program step execution.
3	6	IN 31	—	—
3	7	IN 32	JOG start	【Positioning mode only】 It moves to the XY coordinates specified by "Position command" at the 0⇒1 rising edge of this signal.
4	0-7	IN 33-40	Position 1 signal ~ Position 128 signal	【Positioning mode only】 This signal is the position number to move when JOG starts. (8-bit data that regarded "Position 1 signal" as LSB) The number in the range of 1 to 255 is specified.
5	0	IN 41	IN	If the step in the program is "waiting for IN", step execution is suspended until this signal is input. This signal is used in combination with the output signal "OUT".
5	1	IN	WAIT 3	【Positioning mode only】 This signal temporarily pauses program step execution.
5	2	42-43	WAIT 4	
5	3-4	IN 44-45	—	—
5	5	IN 46	ZJOG rise	By this signal input, raising operation of Z axis is performed.
5	6	IN 47	ZJOG descent	The Z axis is lowered by the input of this signal.
5	7	IN 48	Tightening sampling start	The tightening angle sampling starts at the off⇒on rise of this signal. The tightening setting is performed automatically using the acquired angle by this operation. ※This signal is used only by the setting software function.
6-9	0-7	IN 49-80	—	—
10	0-1	IN 81-82	Retightening signal Retightening mode	These signals are used for retightening.
10	2-6	IN 83-87	—	—
10	7	IN 88	—	—
11	0-7	IN 89-96	—	—
12 -13	0-7	IN 97-112	Heighst 1~16	The correction value for correcting the height of the work is represented by these 1 to 16 signals. The correction value is 16 bits with a sign, and these 1 to 16 represent bit 0 to 15 of the correction value respectively.
14 -17	0-7 ~ 0-5	IN 113-142	Axis off 1~30	This deactivates that axis when this signal is input.
17	6-7	IN 143-144	—	—

4-2-2 Output signal

Output("GSK" ⇒ "PLC")

No.	Bit	I/O	Name	Contents
0	0	OUT 1	Operation ready completed	<p>This signal informs the PLC etc. that the preparation for operation is completed.</p> <p>If this is not output, the system does not energize the nut runner.</p> <p>OFF: Servo motor power off The connected motor can not operate because the power is off.</p> <p>ON: Servo motor power on As the connected motor is turned on, and each operation command becomes Enabled.</p> <p>※It always informs OFF in the following cases.</p> <ul style="list-style-type: none"> • The GSK interface or GSK controller is outputting an alarm. • "Operation ready" of the input signal is 0.
0	1	OUT 2	NR unit OK	<p>This signal indicates that the GSK system is normal.</p> <p>OFF: Device error (alarm occurrence) ON: Device is normal</p>
0	2	OUT 3	Battery OK	<p>This signal is sent to check if the battery for GSK-IF clock is normal.</p> <p>OFF: Voltage error This signal turns off when the voltage drops below 2.5V. When the battery is removed, it takes about 60 seconds to reach this state.</p> <p>ON: Voltage is normal</p> <p>※This signal is only notification. Even in the case of OFF, there is no restriction on operation. (Date and time information will be undefined)</p>
0	3-4	OUT 4-5	Total OK /Total NG	<p>These signals show the result of program operation by automatic operation.</p> <p>At the start of automatic operation, both signals are OFF. Either of these becomes ON when all operations of the specified program number are completed.</p> <p>※Total NG may change to total OK due to QL operation.</p> <p>※These signals do not become on when the program does not work to the end due to "GSK reset" etc.</p>
0	5	OUT 6	NR running	<p>This signal indicates whether the nutrunner axis is operating.</p> <p>OFF: All nutrunner axes in the same unit have stopped. ON: There is a nutrunner axis in operation.</p>
0	6	OUT 7	QL COMP.	<p>This signal will be ON when the QL operation is complete.</p>
0	7	OUT 8	Program running	<p>This signal informs that the program of automatic operation is operating.</p> <p>ON: Working OFF: Stopped</p>
1	0-5	OUT 9-14	Program bit1 ~ Program bit6	<p>The selected program number is notified by these signals. (6 Bit data that regarded "Program bit 1" as LSB)</p>
1	6	OUT 15	Output enabled	<p>This signal indicates that program selection has been completed.</p>
1	7	OUT 16	Z axis home return complete	<p>This signal indicates that the current value of Z axis is the origin.</p>

No.	Bit	I/O	Name	Contents
2	0-1	OUT 17-18	Tightening total OK /Tightening total NG	<p>【In case of multi axis mode】 It is always OFF</p> <p>【In case of positioning mode】 These signals show the result of program operation by automatic operation. At the start of automatic operation, both signals are OFF. Either of these becomes ON when all tightening commands of the specified program number are completed. ※By referring to this signal, the result can be judged earlier than "total OK" or "total NG"</p>
2	2-3	OUT 19-20	X axis home return complete /Y axis home return complete	<p>These signals indicate whether or not the X-axis / Y-axis origin is correctly recognized. OFF: Home return not performed ON: Home return ※If home return is not performed, XY movement by program operation and JOG start can not be performed.</p>
2	4-5	OUT 21-22	ZERO/GAIN OK / ZERO/GAIN NG	<p>These signals signal the results of zero checks and magnification checks in the GSK controller. ZERO/GAIN OK is ON : The zero checks and magnification checks succeeded for all NR axes. ZERO/GAIN NG is ON : There were one or more axes of the zero checks NG or magnification checks NG.</p>
2	6	OUT 23	Cycle stop	This signal becomes ON when a cycle stop occurs.
2	7	OUT 24	OUT	<p>This signal is used in synchronization with the PLC in automatic operation. • It is OFF at the time of start. • If the command of the program has OUT attribute, this signal is output at the processing of the command is completed. Usually it used in combination with the input signal "IN".</p>
3	0	OUT 25	SYNC /MARK Waiting	This signal is output while waiting for a SYNC or WT_MARK command.
3	1	OUT 26	Retightening	This signal indicates that retightening is in operation.
3	2	OUT 27	—	—
3	3	OUT 28	Z axis Pressing	This signal indicates that the Z axis is in pressing operation.
3	4-5	OUT 29-30	Z up Lmt Z down Lmt	<p>Z up Lmt : This signal notifies that the current coordinate of Z axis exceeds the limit of point detection coordinates. Z downLmt : Notifies that the current Z axis coordinate exceeds the point detection coordinate lower limit.</p>
3	6-7	OUT 31-32	Tightening block OK / Tightening block NG	<p>These signals report the tightening results for each block. Either turns on at the end of the block. OK is ON: Tightening was successful for all NR axes NG ON: There were one or more screws of tightening NG. ※These signals may change from NG to OK by the QL procedure. ※This signal does not change at the end of the XY block.</p>
4	0-5	OUT 33-38	Block 1 end ~ Block 32 end	<p>These indicate the block number for which the operation has been completed in automatic operation in binary with each signal as 1 bit. (6 Bit data which regarded Block 1 end as LSB) When the tightening block is completed, the indicated value is incremented by one.</p>
4	6	OUT 39	Position locator running	<p>【Positioning mode only】 OFF: Both X and Y axes stop ON: Both or one of X and Y axes is operating</p>
4	7	OUT 40	Z axis moving	This signal indicates that the Z axis is moving.

No.	Bit	I/O	Name	Contents
5	0-7	OUT 41-48	Position 1 output ~ Position 128 output	【Positioning mode only】 These indicate the current position number in binary with each signal as a bit. (8-bit data where "Position 1 output" is regarded as LSB) If the value indicated by these is 0, it has not reached the coordinates of any number.
6	0-1	OUT 49-50	X extent output 1 X extent output 2	【Positioning mode only】 This signal indicates if the X axis is within a certain range. The range coordinate value is determined by the range output upper and lower limit value of the X axis rating.
6	2-3	OUT 51-52	Y extent output 1 Y extent output 2	【Positioning mode only】 This signal indicates if the Y axis is within a certain range. The range coordinate value is determined by the range output upper and lower limit value of the Y axis rating.
6	4	OUT 53	Interference fault	【Positioning mode only】 This signal turns ON when interference between units occurs.
6	5	OUT 54	Position locator fault	【Positioning mode only】 This signal turns ON when movement of the XY axis specified point number fails.
6	6-7	OUT 55-56	Cylinder 1 advance / Cylinder 1 return	【Positioning mode only】 This signal is for raising and lowering the nut runner axis.
7	0	OUT 57	Z output rang	This signal turns on while the current Z axis coordinate is within the Z range upper limit to lower limit of the Z axis rating.
7	1	OUT 58	Z_UP 1	This signal indicates that it is above the "Z_UP1 command completion position".
7	2	OUT 59	Z_UP 2	This signal indicates that it is above the "Z_UP2 command completion position".
7	3	OUT 60	Z down position	This signal turns ON when the Z-axis coordinate descends to the target position during program operation. It also turns ON when the Z coordinate position specified by the cylinder lowering command or pressing command is reached.
7	4	OUT 61		
7	5	OUT62		
7	6	OUT63	—	—
7	7	OUT 64	Driver Ready	Turns on when all drivers in the unit can be driven. :A driver alarm has occurred. :Drive power supply (200 V) is not supplied to the driver. (Wiring problem etc.) Does not turn on.
8-9	0-7 ~ 0-7	OUT 65-80	—	—
10 - 17	0-7 ~ 0-3	OUT 81-140	Screw 1 OK ~ Screw 60 OK	When the screw tightening operation is successful, the signal of the corresponding screw number turns ON. ※ If screw tightening fails, it will remain OFF, but it may change to 1 due to subsequent re-tightening operation or QL procedure.
17	4	OUT 141	Transferring results	This signal is turned on while transferring the tightening result by FTP.
17	5	OUT 142	Adjustment mode	This signal indicates that coordinate adjustment is possible by teaching.
17	6	OUT 143	Protection warning	Please refer to the "Preventive Maintenance" section.
17	7	OUT 144	Life time warning	Please refer to the "Preventive Maintenance" section.

No.	Bit	I/O	Name	Contents
18	0	OUT 145	Loose complete	The ON state of this signal is the start condition of the retightening mode. When the loosening signal is turned on at the loosening mode, this signal is turned on.
18	1	OUT 146	Loose waiting	This signal indicates that the retightening operation is required when the overall NG is output and the retightening function is effective. It turns off by the signal during retightening.
18	2	OUT 147	Retightening NG	This signal notifies that there was an NG in the result of the retightening operation.
18	3	OUT 148		
18	4	OUT 149		
18	5	OUT 150		
18	6	OUT 151	Automatic operation	This signal outputs that the entire device is in automatic operation.
18	7	OUT 152	During Axis off	Turn on this signal if there is at least one invalid axis on the system.
19	0	OUT 153	Work addition warning	This signal is output when the number of automatic operations reaches the work addition warning value.
19	1	OUT 154	Screw addition warning	This signal is output when the number of screws tightened by automatic operation reaches the screw addition warning value.
19	2	OUT 155	SD card warning	Turns on when the SD card is set and can not write. (SD card write failure etc.)
19	3-6	OUT 156-159	—	—
19	7	OUT 160	Warning	<p>Notifies that some warning has occurred. Even one of the following conditions is ON. (OR condition)</p> <ul style="list-style-type: none"> • "Protection warning" is ON • "Life warning" is ON • "Work accumulated warning" is ON • "Screw integration warning" is ON • "SD card warning" is ON
20 -23	0-7 ~ 0-7	OUT 161-192	—	—

4-3 Input / Output signal map

Input("PLC" ⇒ "GSK")

No.	bit 0	bit 1	bit 2	bit 3	bit 4	bit 5	bit 6	bit 7
0	Operation ready	AUTO /MANU	Start	Inching start	Determination reset	Alarm reset	QL input	QL mode
1	Program bit1	Program bit2	Program bit3	Program bit4	Program bit5	Program bit6	—	GSK reset
2	X JOG +	X JOG -	YJOG +	Y JOG -	INX 1	INX 2	INY 1	INY 2
3	Cylinder1 returned	Cylinder1 advanced	X return signal	Y return signal	WAIT 1	WAIT 2	—	JOG start
4	Position 1 signal	Position 2 signal	Position 4 signal	Position 8 signal	Position 16 signal	Position 32 signal	Position 64 signal	Position 128 signal
5	IN	WAIT 3	WAIT 4	—	—	ZJOG rise	ZJOG descent	Tightening sampling start
6	—	—	—	—	—	—	—	—
7	—	—	—	—	—	—	—	—
8	—	—	—	—	—	—	—	—
9	—	—	—	—	—	—	—	—
=====The following is valid only for UNIT 1 =====								
10	Retightening signal	Retightening mode	—	—	—	—	—	—
11	—	—	—	—	—	—	—	—
12	Height 1	Height 2	Height 3	Height 4	Height 5	Height 6	Height 7	Height 8
13	Height 9	Height 10	Height 11	Height 12	Height 13	Height 14	Height 15	Height 16
14	Axis off 1	Axis off 2	Axis off 3	Axis off 4	Axis off 5	Axis off 6	Axis off 7	Axis off 8
15	Axis off 9	Axis off 10	Axis off 11	Axis off 12	Axis off 13	Axis off 14	Axis off 15	Axis off 16
16	Axis off 17	Axis off 18	Axis off 19	Axis off 20	Axis off 21	Axis off 22	Axis off 23	Axis off 24
17	Axis off 25	Axis off 26	Axis off 27	Axis off 28	Axis off 29	Axis off 30	—	—

Output("GSK" ⇒ "PLC")

No.	bit 0	bit 1	bit 2	bit 3	bit 4	bit 5	bit 6	bit 7
0	Operation ready completed	NR unit OK	Battery OK	Total OK	Total NG	NR running	QL COMP.	Program running
1	Program bit1	Program bit2	Program bit3	Program bit4	Program bit5	Program bit6	Output enabled	Z axis home return complete
2	Tightening total OK	Tightening total NG	X axis home return complete	Y axis home return complete	ZERO /GAIN OK	ZERO /GAIN NG	Cycle stop	OUT
3	SYNC /MARK Waiting	Retightening	—	Z axis Pressing	Z up Lmt	Z down Lmt	Tightening block OK	Tightening block NG
4	Block 1 end	Block 2 end	Block 4 end	Block 8 end	Block 16 end	Block 32 end	Position locator running	Z axis moving
5	Position 1 output	Position 2 output	Position 4 output	Position 8 output	Position 16 output	Position 32 output	Position 64 output	Position 128 output
6	X extent output 1	X extent output 2	Y extent output 1	Y extent output 2	Interference fault	Position locator fault	Cylinder advance	Cylinder return
7	Z output range	Z_UP 1	Z_UP 2	Z down position			—	Driver Ready
8	—	—	—	—	—	—	—	—
9	—	—	—	—	—	—	—	—
=====The following is valid only for UNIT 1 =====								
10	Screw 1 OK	Screw 2 OK	Screw 3 OK	Screw 4 OK	Screw 5 OK	Screw 6 OK	Screw 7 OK	Screw 8 OK
11	Screw 9 OK	Screw 10 OK	Screw 11 OK	Screw 12 OK	Screw 13 OK	Screw 14 OK	Screw 15 OK	Screw 16 OK
12	Screw 17 OK	Screw 18 OK	Screw 19 OK	Screw 20 OK	Screw 21 OK	Screw 22 OK	Screw 23 OK	Screw 24 OK
13	Screw 25 OK	Screw 26 OK	Screw 27 OK	Screw 28 OK	Screw 29 OK	Screw 30 OK	Screw 31 OK	Screw 32 OK
14	Screw 33 OK	Screw 34 OK	Screw 35 OK	Screw 36 OK	Screw 37 OK	Screw 38 OK	Screw 39 OK	Screw 40 OK
15	Screw 41 OK	Screw 42 OK	Screw 43 OK	Screw 44 OK	Screw 45 OK	Screw 46 OK	Screw 47 OK	Screw 48 OK
16	Screw 49 OK	Screw 50 OK	Screw 51 OK	Screw 52 OK	Screw 53 OK	Screw 54 OK	Screw 55 OK	Screw 56 OK
17	Screw 57 OK	Screw 58 OK	Screw 59 OK	Screw 60 OK	Transferring results	Adjustment mode	Protection warning	Life time warning
18	Loose complete	Loose waiting	Retightening NG				Automatic operation	During Axis off
19	Work addition warning	Screw addition warning	SD card warning	—	—	—	—	Warning
20	—	—	—	—	—	—	—	—
21	—	—	—	—	—	—	—	—
22	—	—	—	—	—	—	—	—
23	—	—	—	—	—	—	—	—

4-4 Selection of communication with sequencer

The communication that GSK-IF can connect as standard is M-NET.

GSK-IF reads the ID of each board when power is turned on and operates according to each communication. And so there is no change of communication switching settings.

4-4-1 Type Difference by Communication Method

Communication method	Model
M-NET	GSK-IF-N7
DeviceNet	GSK-IFDN-N7
CC-LINK	GSK-IFCC-N7
EtherNet/IP	GSK-IFET-N7
PROFINET IO	GSK-IFPNIO-N7

Functional differences with M-NET

The I/O signal map does not change even if the communication standard changes. However, there are the following functional differences.

Communication method	Off axis information	Tightening result notification
M-NET	×	×
Device-Net	○	○
CC-LINK	○	○
EtherNet/IP	○	○
PROFINET IO	○	○

5. Operation timing chart

5-1 Power on and inching operation

(It will work at the speed and direction setting of rotation and inching that has been selected (1 to 24) by the program selection signal (1 to 5))

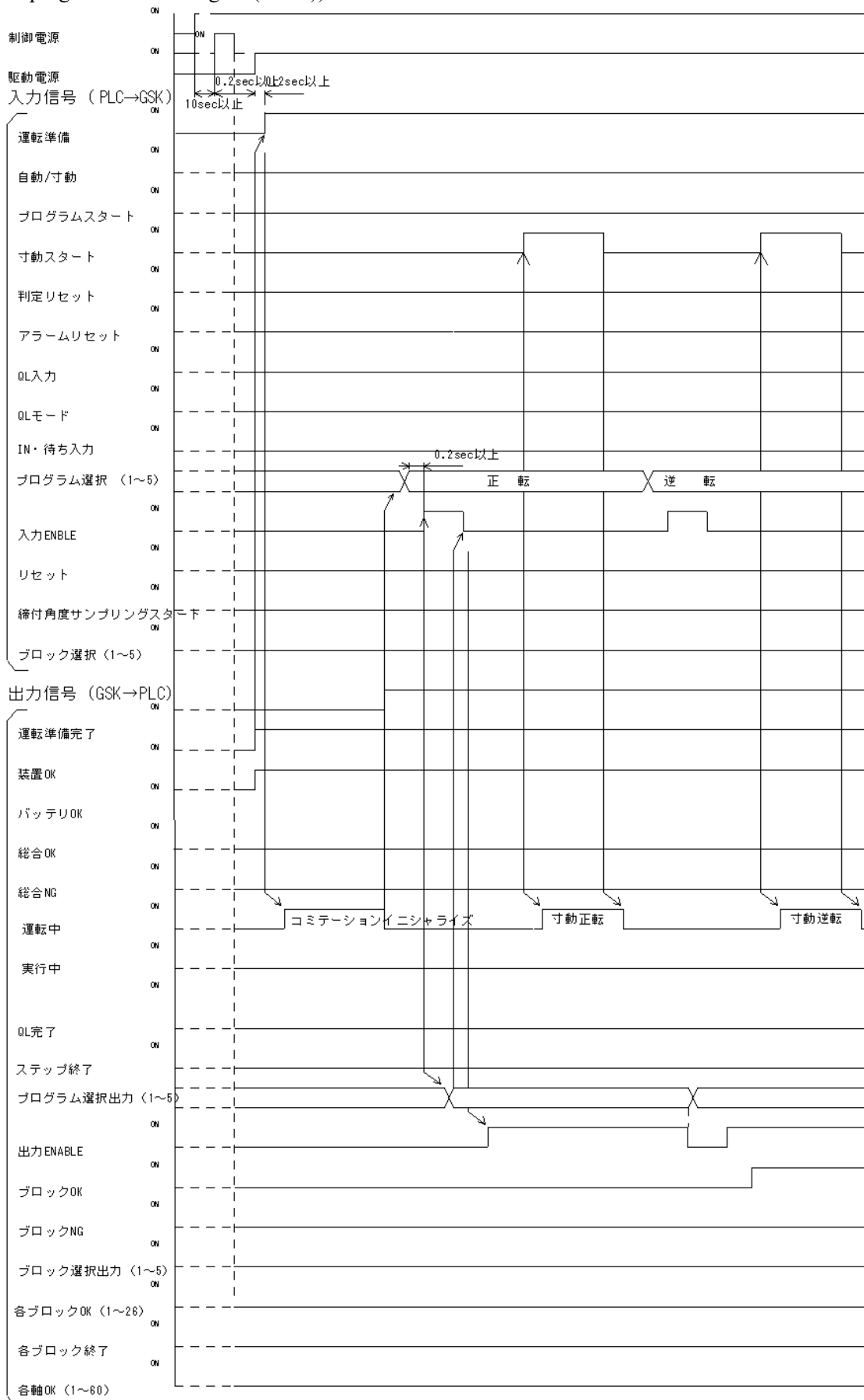

5-2 Program operation - 2 step operation 1

(1 block setting, if the judgment OK)

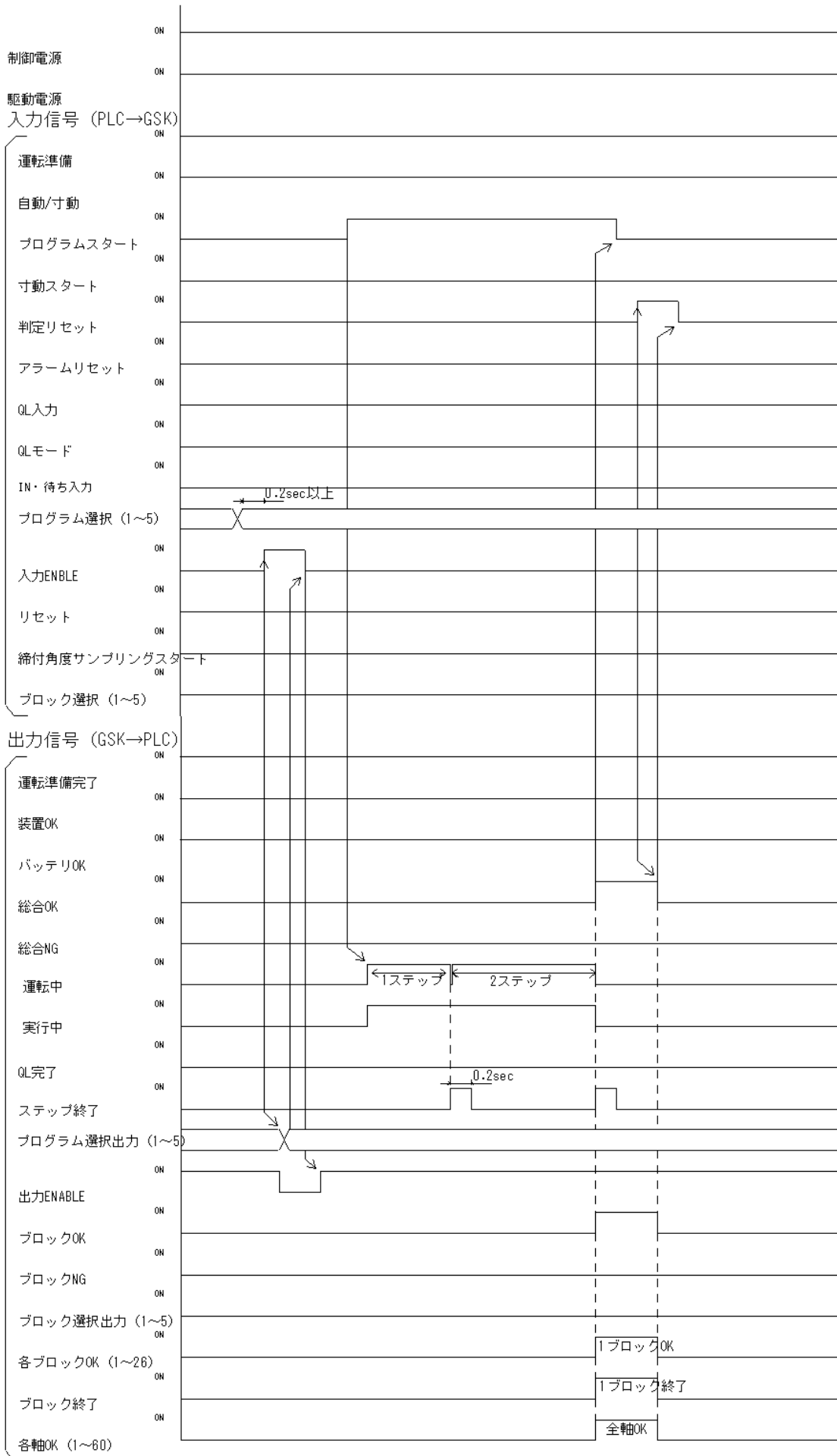

5-3 Program operation - 2 step operation 2

(When 1 block has settings of the 3 axis, first and second axis become NG at first step, third Axis is OK up to a two-step: there is QL process)

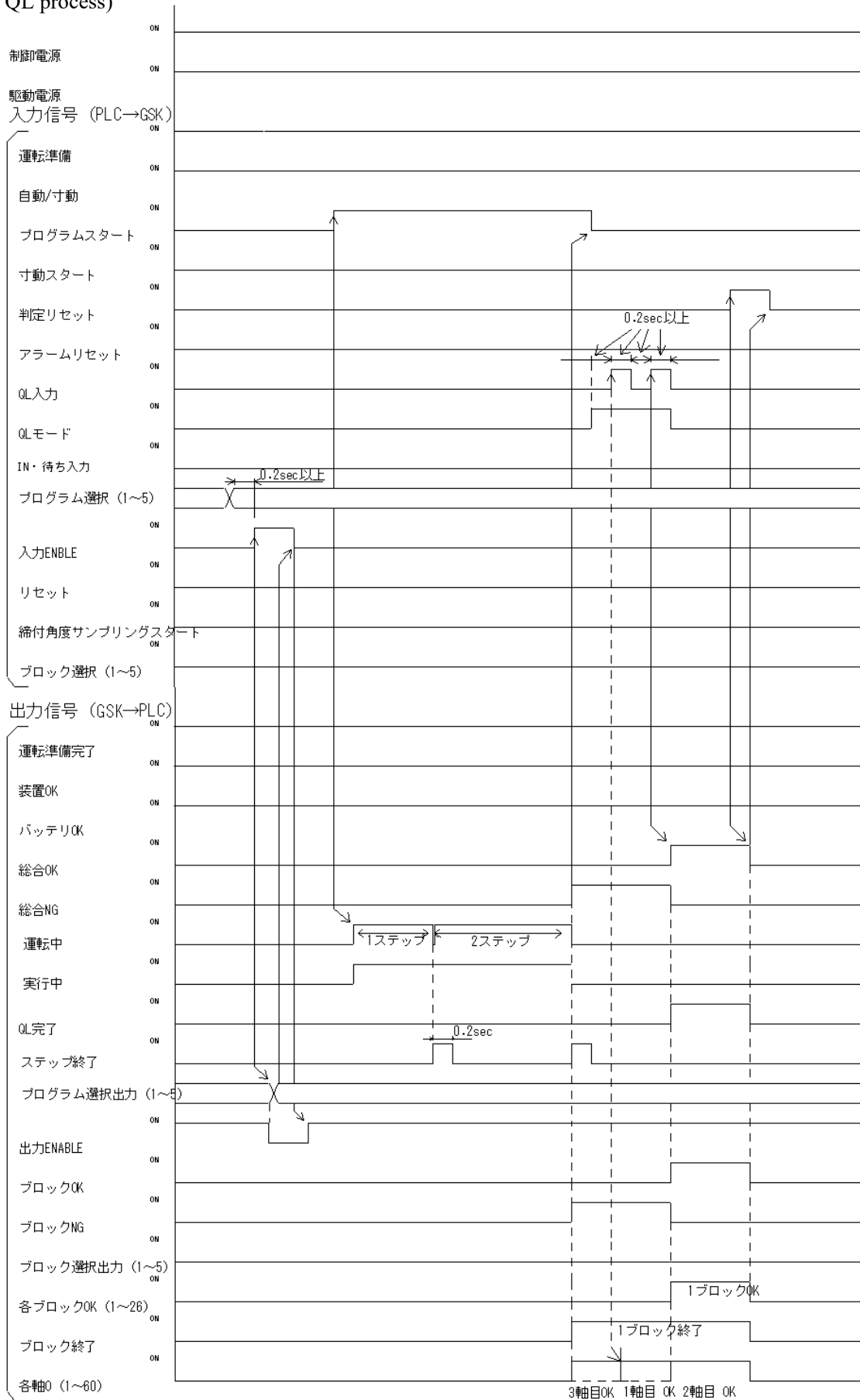

5-4 Program operation - 2 step operation 3

(When 1 set block has the 2 axis, first axis become NG at first step, second axis is OK up to a two-step: QL process is nothing)

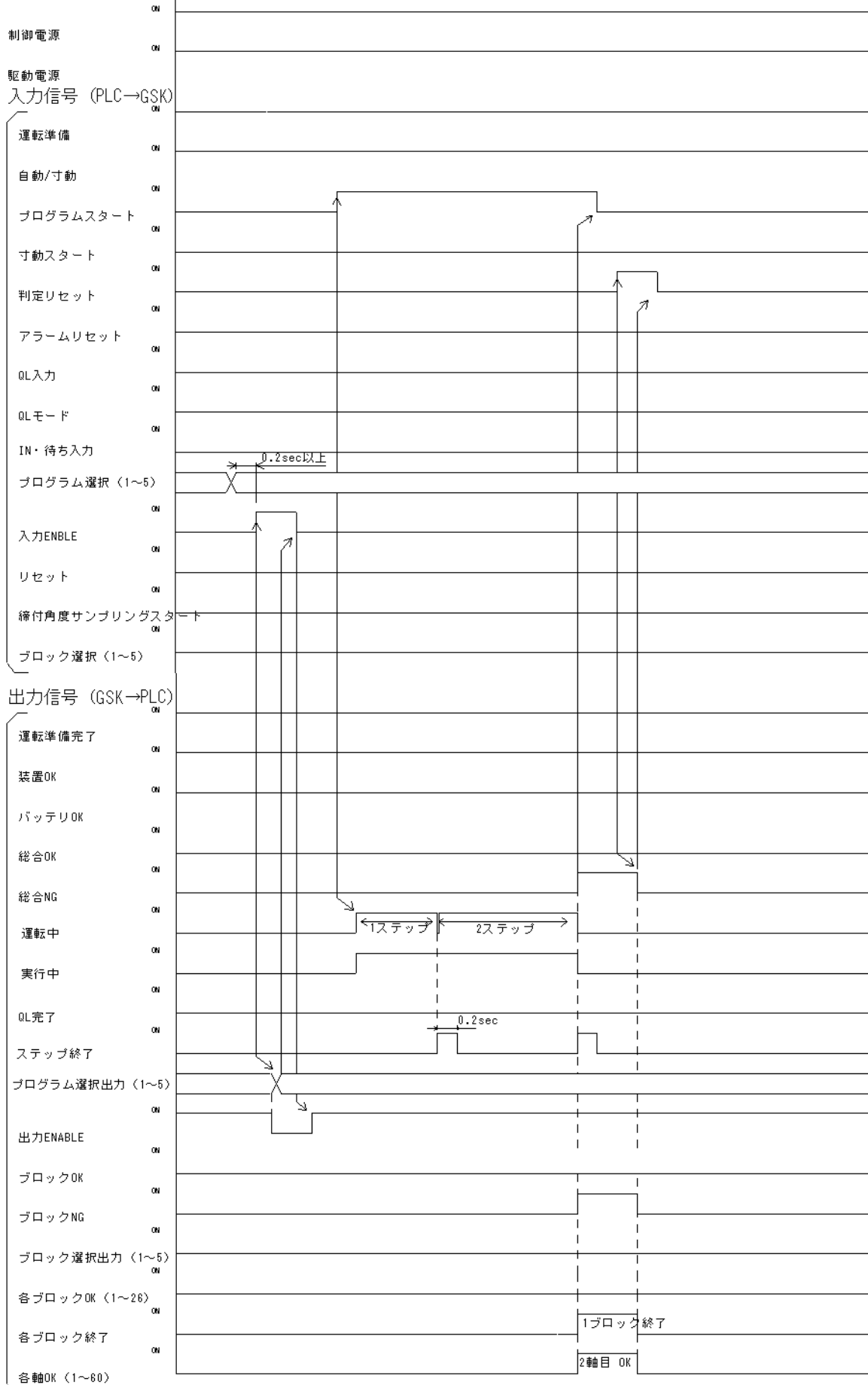

5-5 Program operation - 1 step operation 1

(2 block setting of, among the three axes, 1 and 2-axis is the first block NG, 3 Axis OK,
2 th block all axes OK : 1 block after QL)

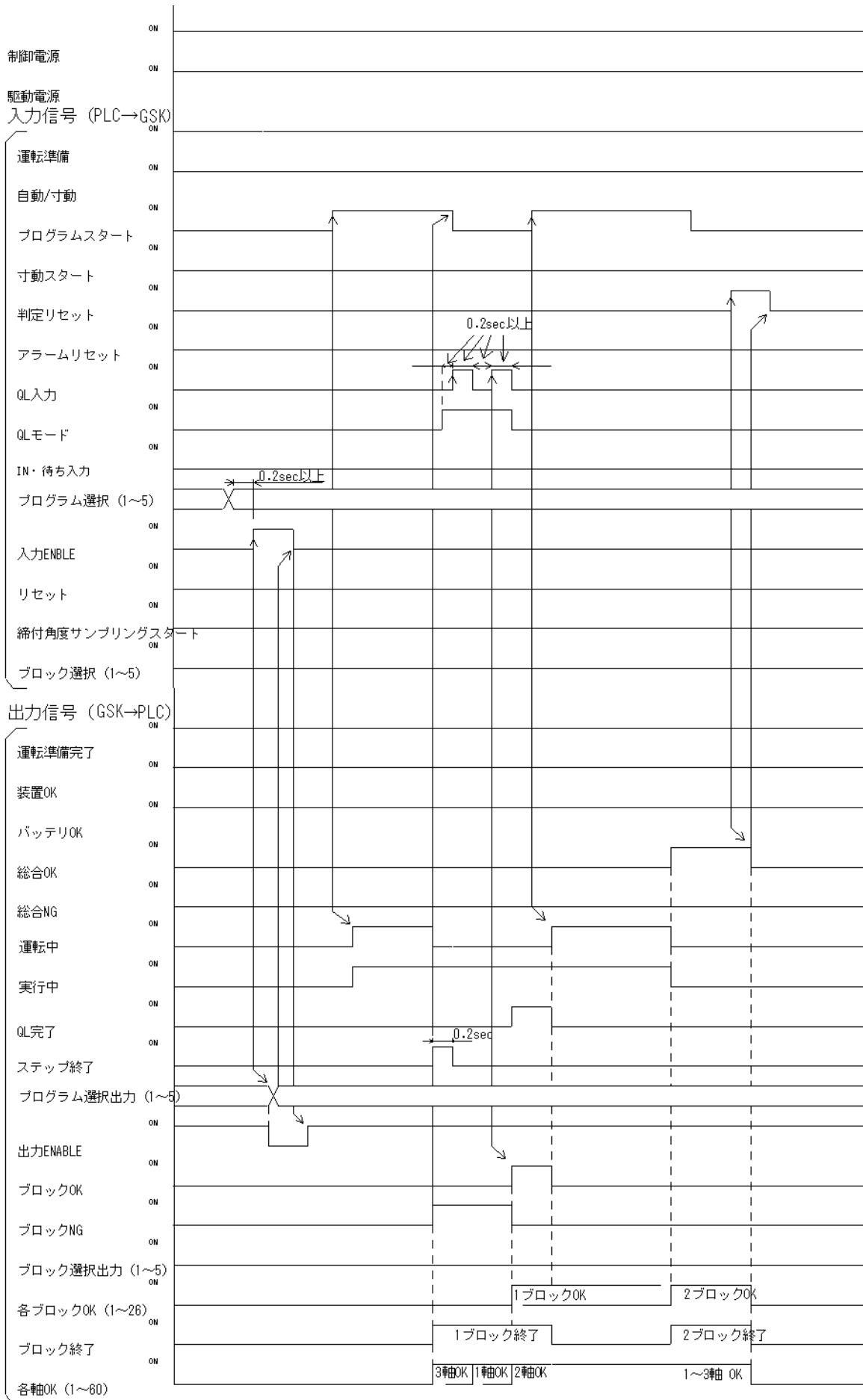

5-6 Program operation - 1 step operation 2

(2 block setting of, among the three axes, 1 and 2-axis is the first block NG, 3 Axis OK,
2 th block all axes OK: at the end of the program collectively QL)

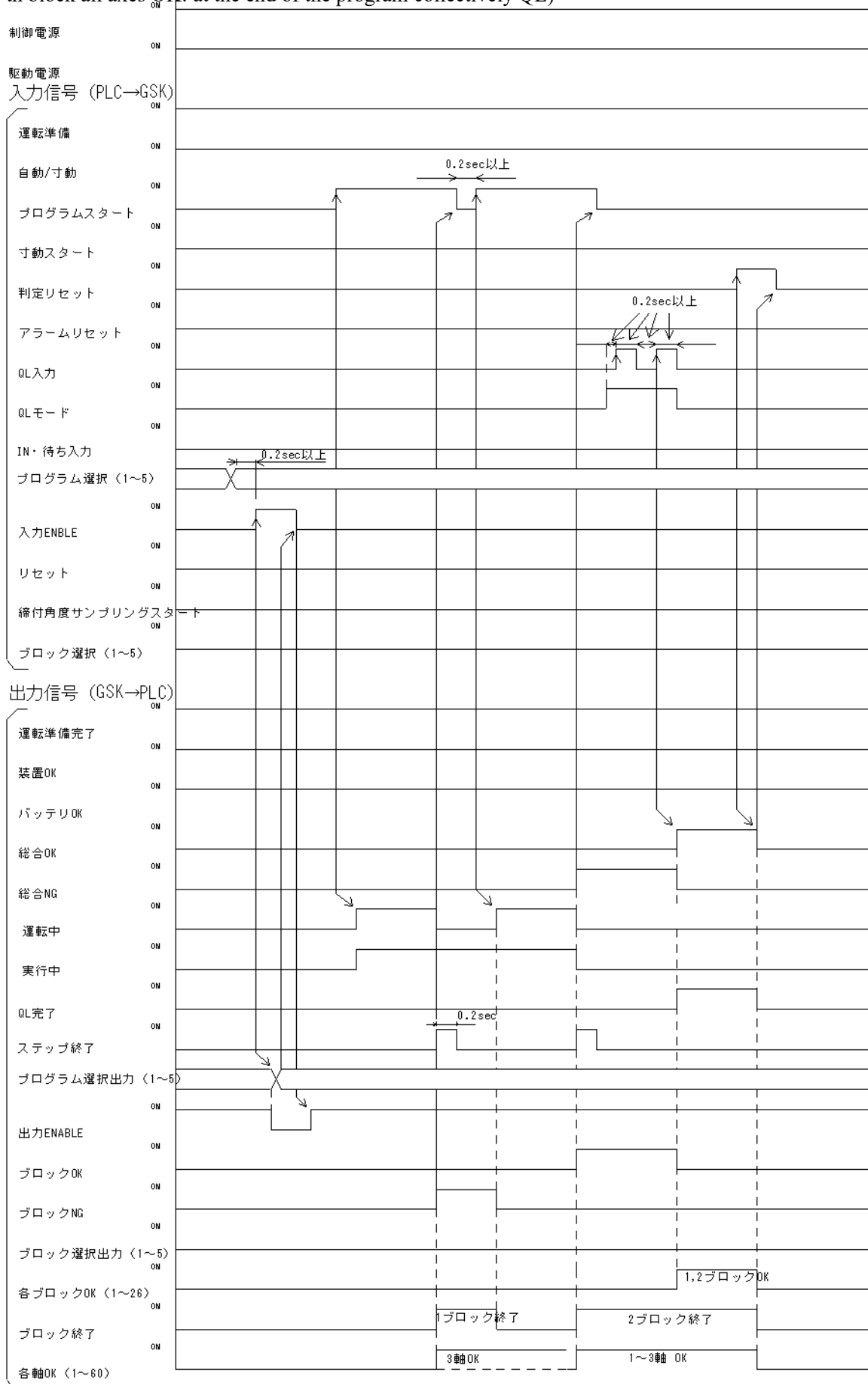

5-7 Program operation - 2 step operation 4

(1 block, there is IN set ting to the second step)

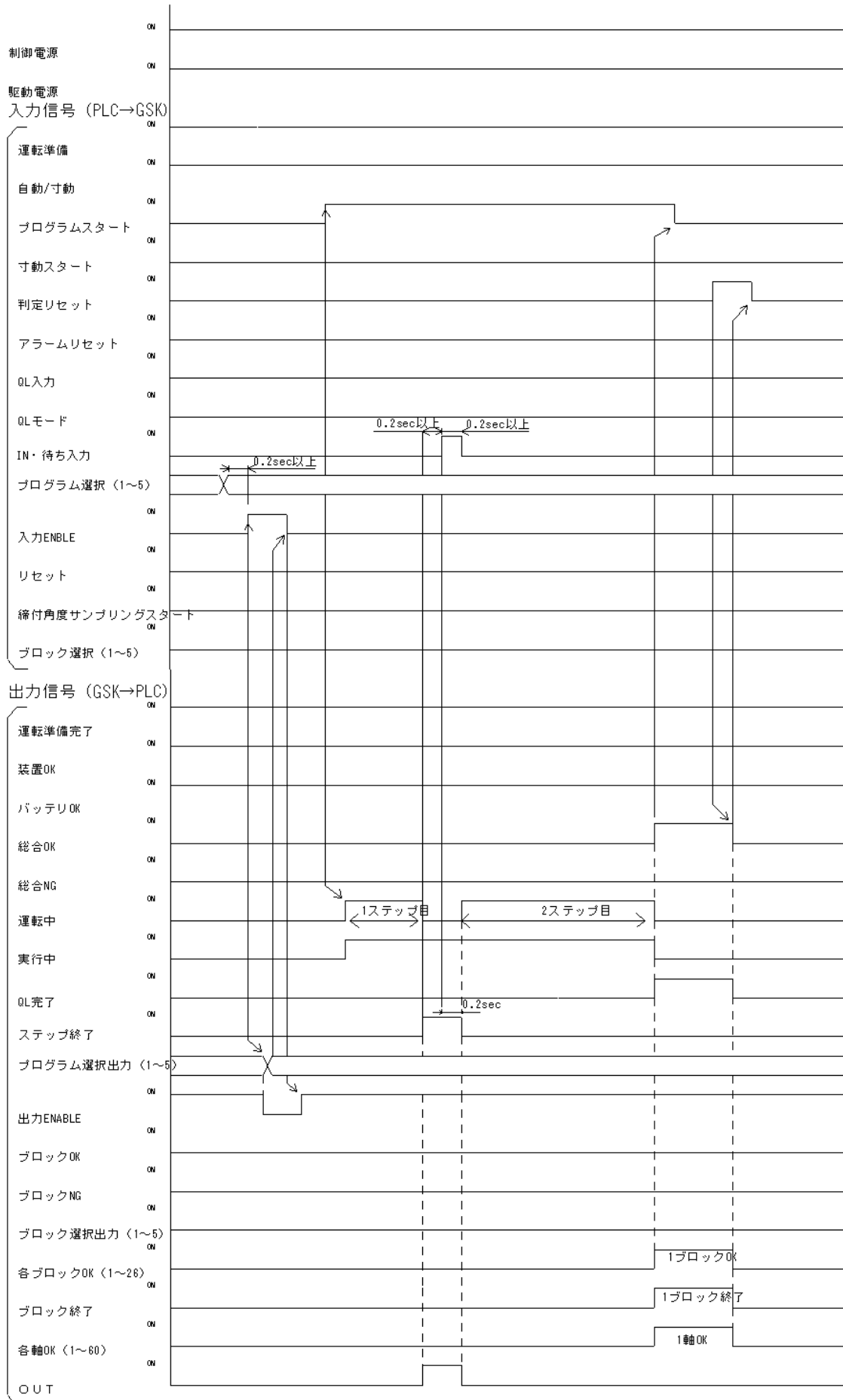

5-8 Program operation - 1 step operation 3

(3 blocks, if allowed to operate in the block order specified by the block selection signal:

When the block select 1 to 5 are all OFF will operate from the block 1 in the order)

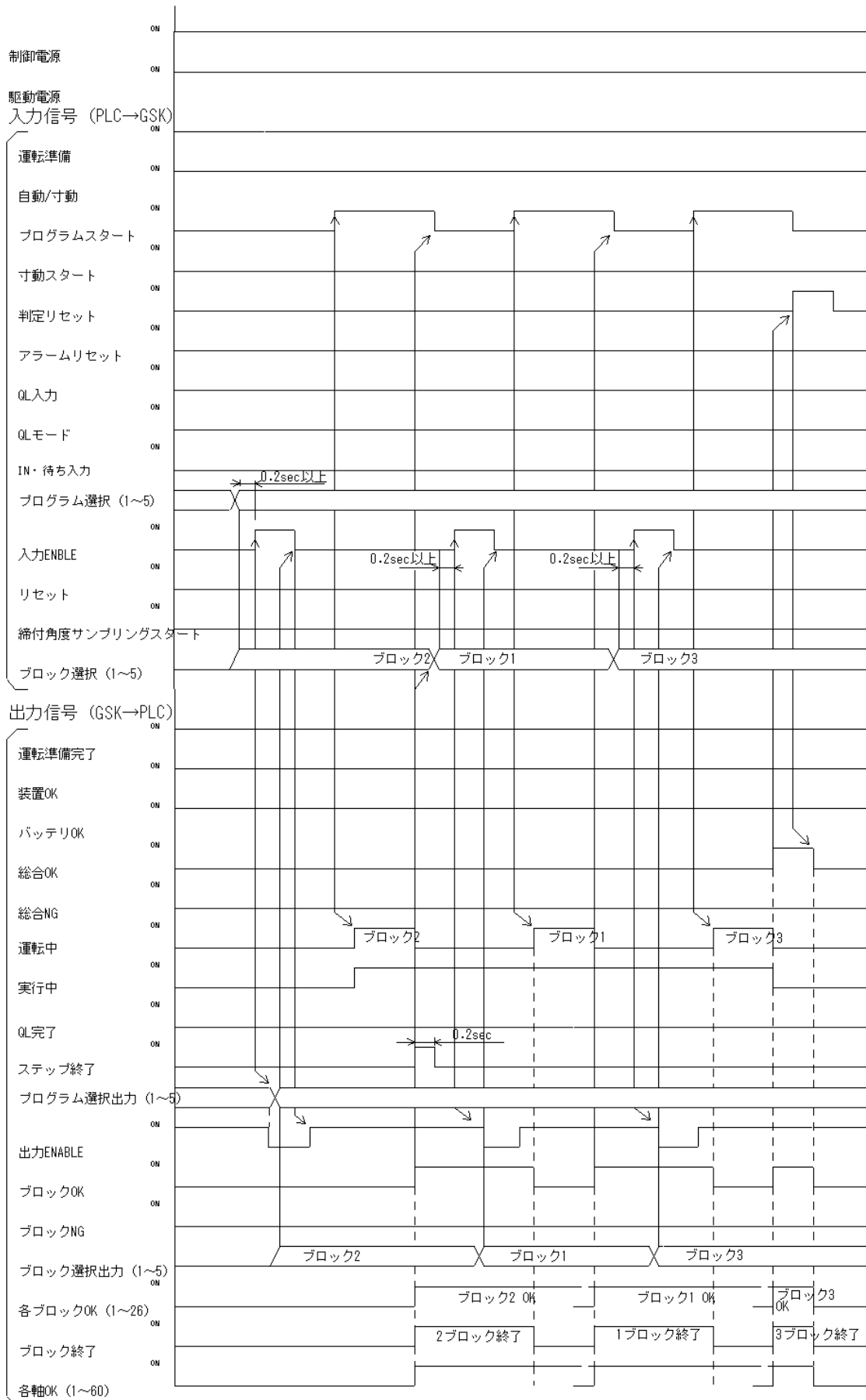

5-9 Interruption of program operation (reset)

(And if one block after the end of reset in one step × 2 blocks operation is turned ON
If it became a reset or ON in the first block of the operation)

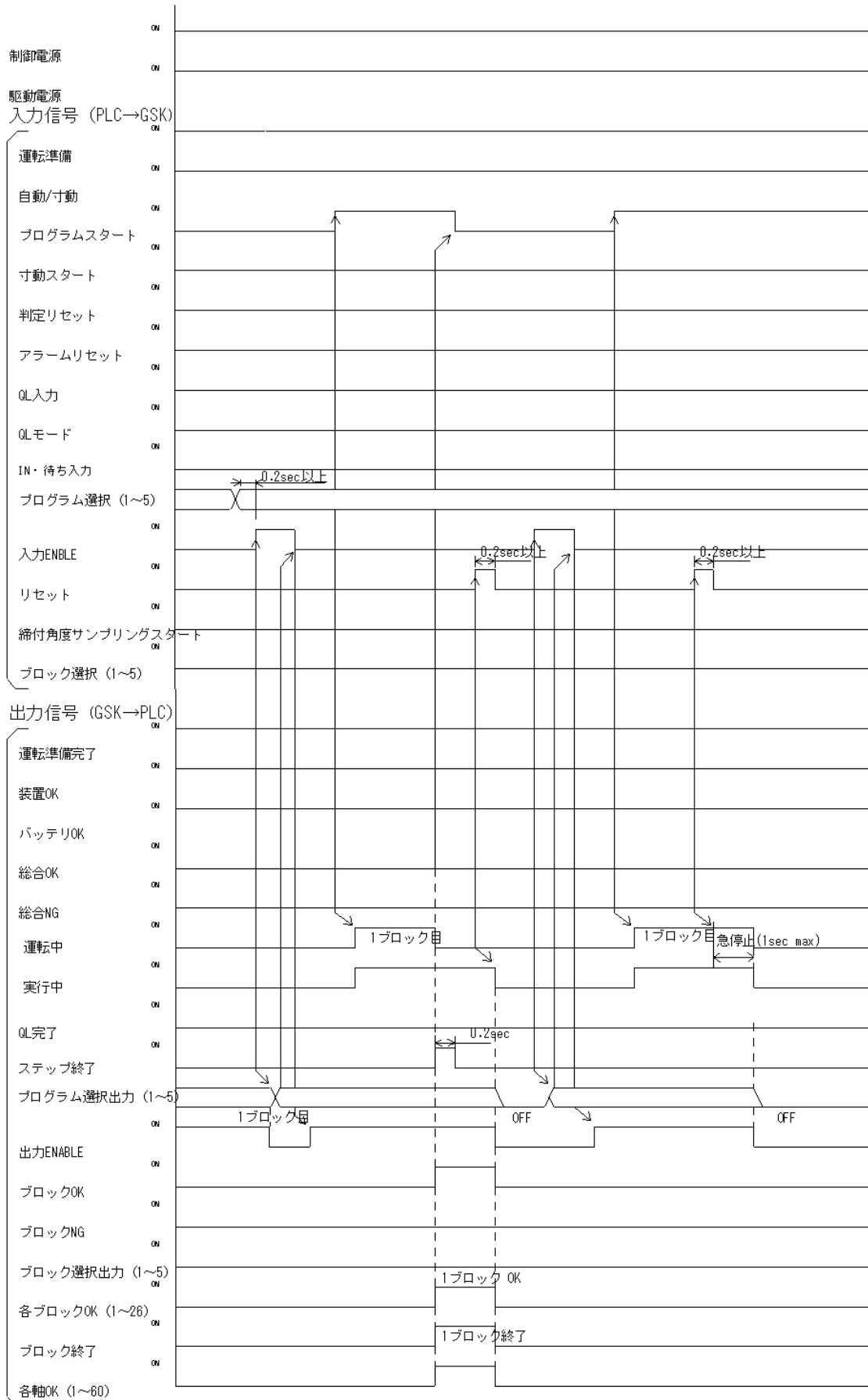

5-10 Operation ready OFF and Start OFF at Program operation

(At the 1 step × 2 blocks program, "Operation preparation OFF" occur in the first block and "program start off" occur the 2nd block.)

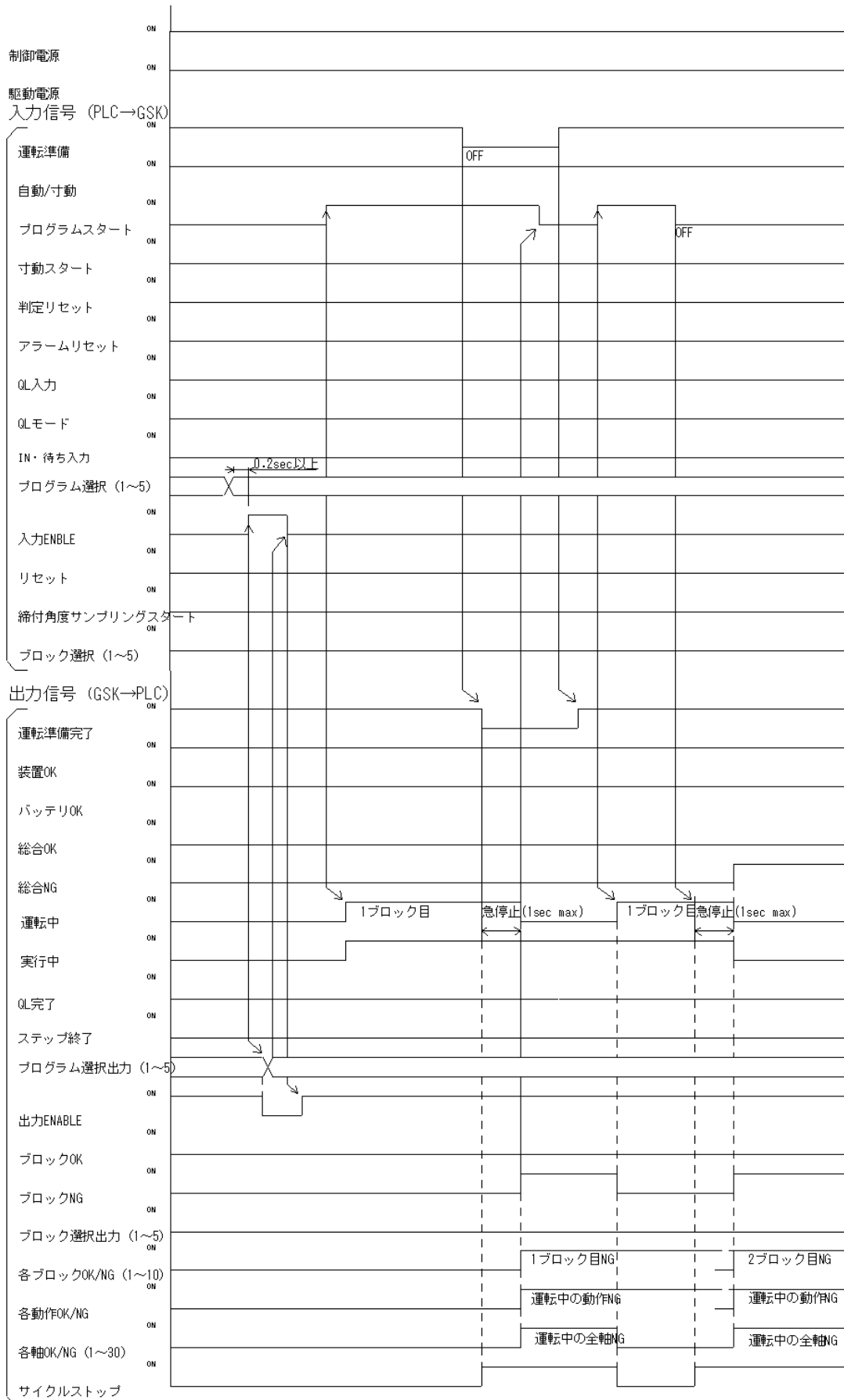

5-11 Alarm output and alarm reset during program operation

(At the 1 step × 2 blocks program, the alarm occurs in the middle of first block, if that was allowed to restart after the alarm reset)

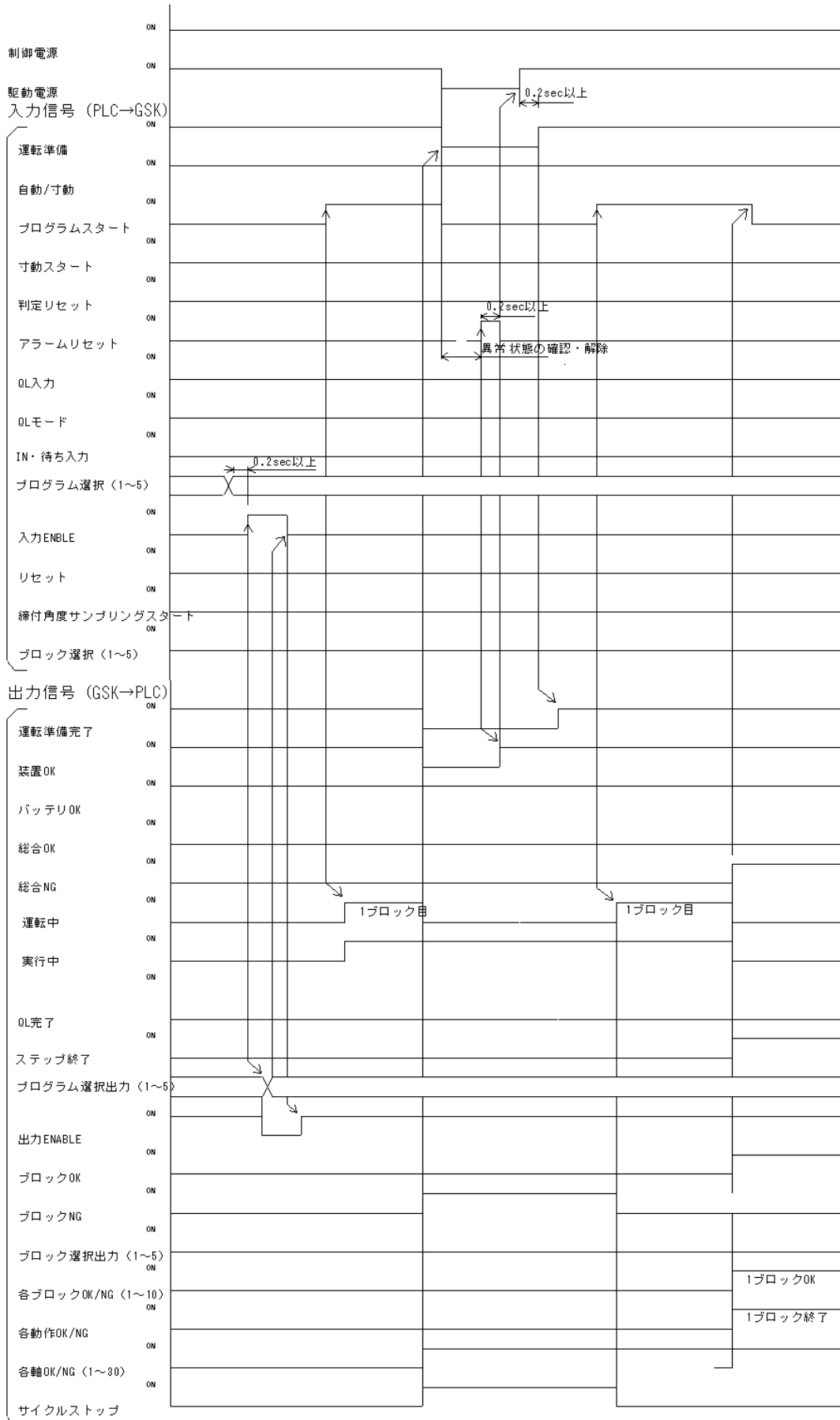

5-12 Tightening angle sampling operation

(It will start the operation at the tightening angle sampling start signal turn ON in the state of Completion of operation preparation.)

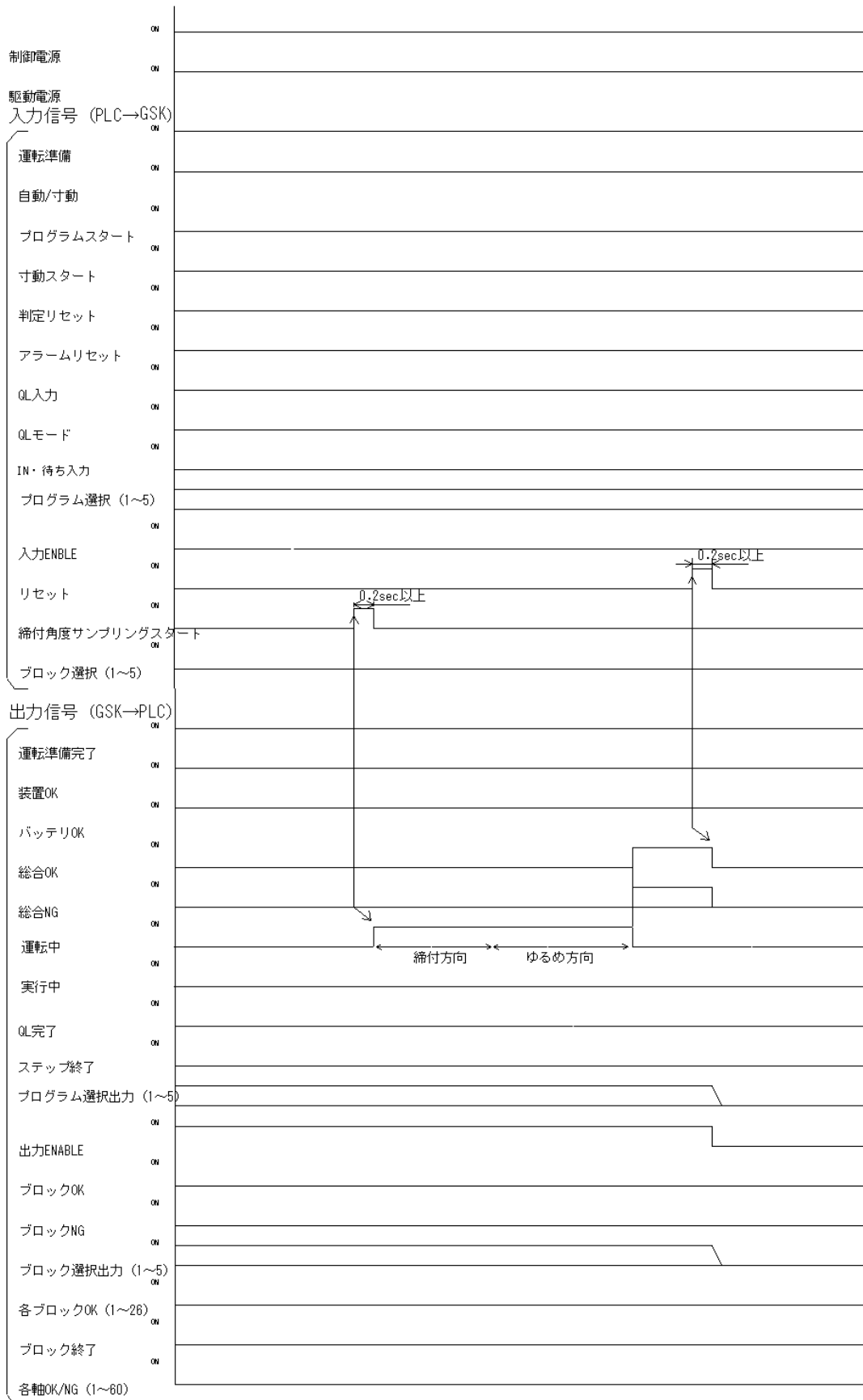

6. Setting

6-1 Display / setting function

It will display the each kinds data, parameters and condition by the 7SEG.LED 6-digit.
You can change the settings in the push-button operation.

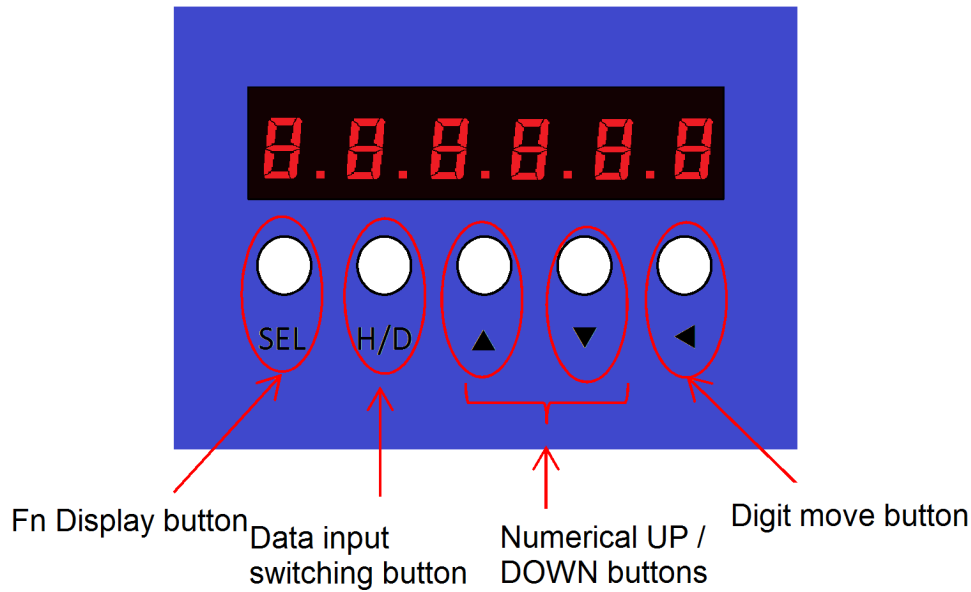

6-1-1 About the viewpoint of the display





7SEG Display	Matter												
<p>2-axis side 1-axis side</p>	<p>When the program unselected</p> <p>State from 1 to 3 digit 1 axis side State from 4 to 6 digit 2 axis side</p>												
	<p>When the servo OFF</p>												
<p>Operation Number</p>	<p>When the servo ON</p> <p>Under 1 digit operation number</p> <table border="1"> <tr> <td>1: SOC.T</td> <td>7: Stop</td> </tr> <tr> <td>2: PRE.T</td> <td>8: Angle measurement tightening</td> </tr> <tr> <td>3: REV.T</td> <td>C: PRE.T end synchronization</td> </tr> <tr> <td>4: REA.T</td> <td>E: REA.T end synchronization</td> </tr> <tr> <td>5: Inching</td> <td></td> </tr> <tr> <td>6: Zero times check</td> <td></td> </tr> </table>	1: SOC.T	7: Stop	2: PRE.T	8: Angle measurement tightening	3: REV.T	C: PRE.T end synchronization	4: REA.T	E: REA.T end synchronization	5: Inching		6: Zero times check	
1: SOC.T	7: Stop												
2: PRE.T	8: Angle measurement tightening												
3: REV.T	C: PRE.T end synchronization												
4: REA.T	E: REA.T end synchronization												
5: Inching													
6: Zero times check													
<p>Alarm code</p>	<p>Alarm " * * " occurs</p> <p>The last two digits are the alarm code .</p>												



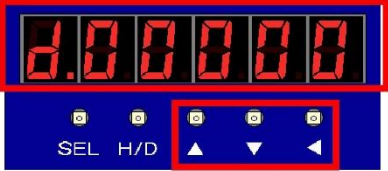

6-1-2 Setting example

For GSK · GSKW, each parameter can be changed by using the bottom button of 7 SEG display part.
Here, we will explain the setting of representative parameters using 7 SEG display by using several examples.
For the setting place etc. of each parameter, please refer to paragraph 7.

6-1-3 Procedure of setting axis number

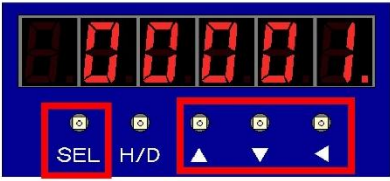
When assembling equipment with GSK, you have to recognize each axis to number of each axis's own number.
Here, the setting procedure is shown below.

StepNo.	Image	Description
1		The screen on the left is the normal screen. Please press the SEL button to change the parameter.
2		When you press the SEL button in step 1, you will see the screen on the left. A digit with a blinking dot can become operable by ▲, ▼ buttons. Please move the dot position to F by pressing the most right button.
3		Dot came at F. In this state, press ▲ or ▼ to select the function you want to set or monitor. For the item, please refer to 7-1. It will take an axis setting as an example this time. Please select d for that. Please change F to d with ▲ or ▼.
4		You complete the selection d on the left screen. Please change the displayed value to "d00177" to change the address. When setting the second axis using the W type controller, please set the display value to "d10177".
5		The screen on the left is the screen where you enter the address. Change the numerical value with ▲ and ▼ buttons, and when you complete, You move to the next digit with the left direction button.
6		You finished entering the address "d00177". Press the H / D button to display the setting in the address.

7		<p>Enter the axis number.</p> <p>Use the left button to change the number of digits and change the numerical value with ▲ or ▼ buttons.</p> <p>When setting of the axis number is completed, please push the SEL button.</p> <p>You will return to the address setting screen.</p>
8		<p>Save the installed axis number.</p> <p>When you press and hold the left triangle button for about 2 seconds on the address setting screen, the screen of 7-SEG flashes twice.</p> <p>After this blinking is completed, the set data is saved.</p>
9		<p>When saving of data is completed, it returns to the operation screen from the parameter setting screen.</p> <p>Please move the position of the dot to d with the left button and set it to F with the ▲ or ▼ button.</p>
10		<p>When the leftmost 7-SEG becomes F, the screen on the left is displayed.</p> <p>Press the H / D button to return to the operation screen.</p> <p>At this time, if the number of Fn is other than "Fn 0 - 00", please note that even if you press the H / D button you can not return.</p>

※Please set the controller axis numbers so that they do not overlap.

6-1-4 Procedure to erase the 7 segment display of W type unused axis

There are circumstances such as using only one axis when using W type.

If you don't set the axis number, you can use W type as it is.

However, 7 SEG on the unused axis continues to discharge the sensor unconnected alarm.

(In this case, you can ignore the alarm and tighten the screw.)

Here is the procedure for setting to erase the indication of the unused axis which discharges the alarm.

StepNo.	Image	Description
1		We change the parameters to erase the second axis display of GSKW. Please press the "SEL" button to open the function screen.
2		It moves from function screen to driver data change screen. Please move to "d00000" to use "△", "▽", "◀" buttons. "." is the selected digit. You can move to the target screen by pressing "▽" twice in accordance with "F".
3		The driver data screen is now displayed. Please change the display to "d10181" using the "△", "▽", "◀" buttons.
4		The display becomes "d10181". This shows the parameter address for ON / OFF of the second axis display in the GSKW controller. Please press the "H / D" button to display the data inside the address.
5		"D10181" data was displayed. In this example, turn off the display on the 2nd axis side, so press the "△" button once to set it to "00001".
6		It was changed to "00001". Please press "SEL" button to return to the address setting screen.
7		When it comes to the display on the left figure, it returns to the address setting screen. Please hold "◀" for 2 seconds. When the blinking is completed, the previous change is saved. Please temporarily turn off the control power supply of this driver and turn on the power again.
8		After turning on the power again, if the right three digits are displayed as shown in the left figure, the parameter rewriting is successful.

※This setting procedure is available only after GSK version "1851-2.18".



Please note that the display on the 2 axes side will not disappear even if this setting is made in earlier versions.

6-1-5 Procedure of changed tightening sampling stop torque

It setting When you set the tightening method from the PC, there is a sampling setting as a method for making that setting. Here, we show how to set the target torque of the sampling operation to automatically collect the tightening information with the setting method.

(The tightening sampling stop torque has an initial value of 0.

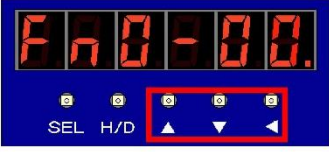
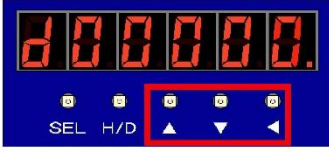
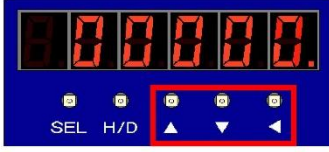
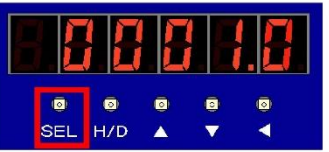





For that reason, sampling setting can not be used unless that it sets the torque by this procedure.)





工程No.	Image	説明
1		It sets the tightening sampling stop torque which is necessary for the sampling setting of the auto setting. Please press the "SEL" button to open the function screen.
2		It moves from function screen to driver data change screen. Please move to "d00000" to use "△", "▽", "◀" buttons . "." is the selected digit. You can move to the target screen by pressing "▽" twice in accordance with "F".
3		The driver data screen is now displayed. Please change the display to "d00174" using the "△", "▽", "◀" buttons.
4		The display becomes "d00174" now. This shows the tightening sampling stop torque for each axis of GSK. Please press the "H / D" button to display the data inside the address.
5		"d00174" data will be displayed. Please enter the torque you want to set here in units of [Nm]. For this example, please change it to "00010" to set 10 [Nm].
6		It was changed to "00010". Please press "SEL" button to return to the address setting screen.
7		When it comes to the display on the left figure, it returns to the address setting screen. Please hold "◀" for 2 seconds. When the blinking is completed, the previous change is saved. You turn on the power again, after it turns off the control power of this driver once. Since then, please start sampling setup.

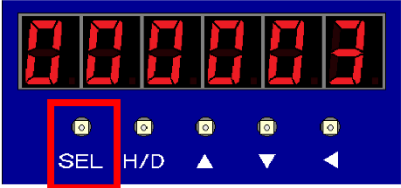
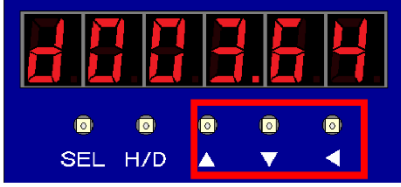
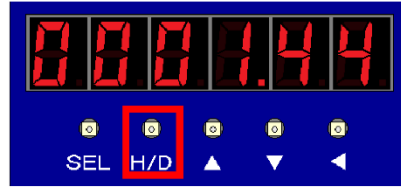

6-1-6 Procedure to change overload alarm threshold

This alarm is output when the average motor current exceeds the overload alarm threshold.

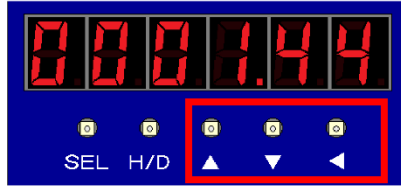
Here we show how to read the average current value of the motor, the rated current value of the motor, and how to set the threshold based on it.

StepNo.	Image	Description
1		The left screen is the normal 7SEG screen. Please press the SEL button to change the parameter.
2		Please press the SEL button in process 1 to display the screen on the left. Digits with blinking dots can be operated with the ▲ and ▼ buttons. Please move the dot position to F by pressing the rightmost left triangle button.
3		The dot came to F. In this state, press ▲ or ▼ to select the function you want to set or check. Please refer to 7-1 for items. This time you select "d" to use the axis setting as an example. Change F to d with ▲ or ▼.
4		You were able to select "d" on the left screen. Change the address display value to "d00364" to confirm the parameter. When setting the second axis using a W-type controller, change the display value on the right side of "d" to "1" and set the display value to "d10364".
5		The screen on the left is the screen where the address "d00364" is entered. Use the ▲ and ▼ buttons to change the value, and when finished, use the left button to move to the next digit.
6		The input of address "d00364" is now complete. Press the H / D button to display the parameters in the address.

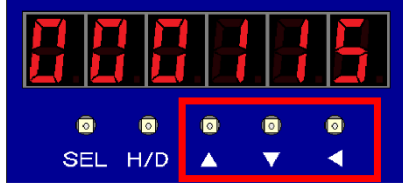
7		<p>Here, the average current value of the motor used for overload detection is monitored.</p> <p>The overload judgment is performed based on what percentage of the rated current the average current has reached.</p> <p>Check the maximum value during operation and return to the address setting screen with the SEL button.</p>
8		<p>After returning to the address setting screen, enter "d00144" to check the rated current of the connected motor.</p>
9		<p>The input of "d00144" is finished.</p> <p>Press the H / D button to display the settings in the address.</p>
10		<p>Check the motor's rated current here.</p> <p>Overload judgment is performed based on what percentage of the value of step 7 is above this value.</p> <p>After confirmation, return to the address setting screen with the SEL button.</p>
11		<p>After confirming the rated current of the motor, set the overload detection level next.</p> <p>The address of the overload detection level is "d00104".</p> <p>Enter "d00104" using the ▲ and ▼ buttons and the left button.</p>
12		<p>The input of "d00104" is finished.</p> <p>Press the H / D button to display the settings in the address.</p>

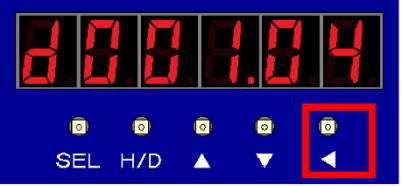
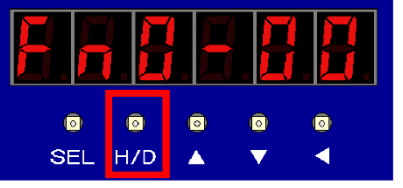
13		<p>The current overload level is displayed. The initial value is “100” or “115”, and it is not detected unless a load exceeding the motor capacity is applied. Enter with the ▲ and ▼ buttons and the left button.</p>
14	$\frac{\text{Any max value of d00364} \times 100}{\text{The value of d00144}}$	<p>The formula on the left is the formula for calculating the value to be changed in step 13. The decimal part is rounded down. For example, if the value of “d00144” is 330 and the value of “d00364” is 30 or more and an overload alarm is issued, enter 10.</p>
15		<p>When you finish entering values, return to the address setting screen to confirm the input data. Press the SEL button to return to the address setting screen.</p>
16		<p>After changing the data in steps 13 to 15, press and hold the left button on this screen to confirm the change. If you hold down the left button for about 2 seconds, 7-SEG will flash on the screen. When blinking, the data is confirmed.</p>
17		<p>When the data is confirmed in step 16, the work is completed. Turn off the power or return to the left screen and press the H / D button to exit the parameter change screen.</p>

6-2 Program configuration

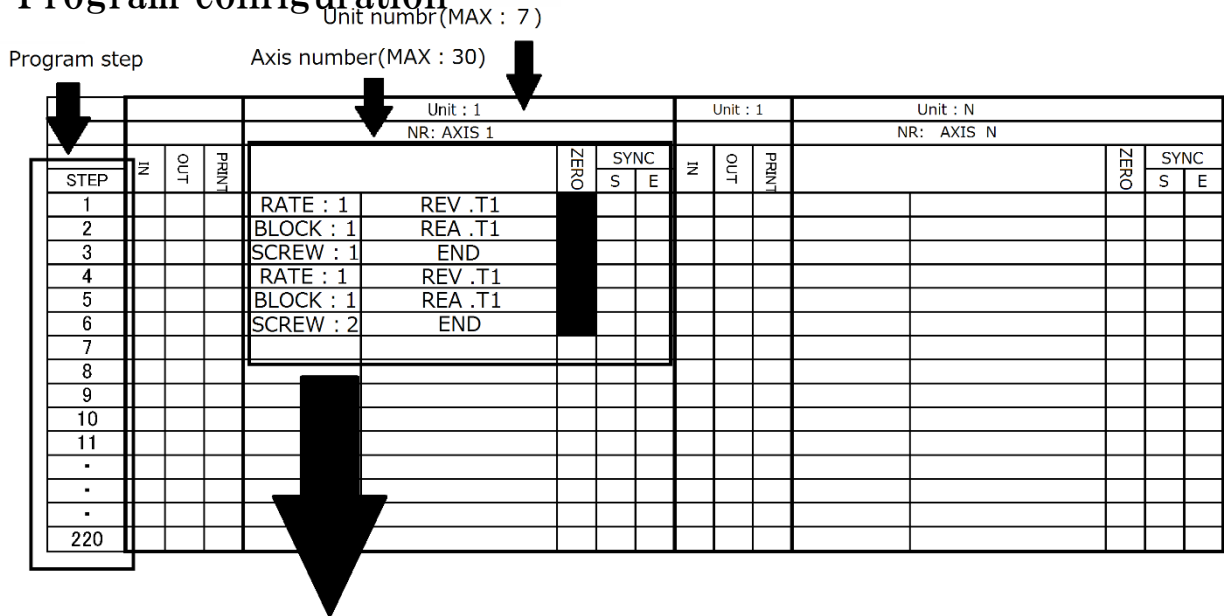

Unit : 1		NR: AXIS 1		ZERO	SYNC
				S	E
※2	RATE : 1	※1	REV.T1		
	BLOCK : 1		REA.T1		
	SCREW : 1		END		
	RATE : 1		REV.T1		
	BLOCK : 2		REA.T1		
	SCREW : 2		END		

※1: The established movement content in the block of ※2

※2: You will set the following items by the "Tightening block operation select" in the "PROGRAM SET"

Rate : Rated setting of the nut runner to be used

Block: Operation content which is set by the block control
You will set the contents of the block from the tightening parameter settings for the following.

Screw: This represents the screw number of the tightening target.

User program data structure

Programrate	Number of axes	Number of programs	Number of blocks	Number of steps
1	30	16	256	220
2	30	50	256	70
3	8	50	256	220

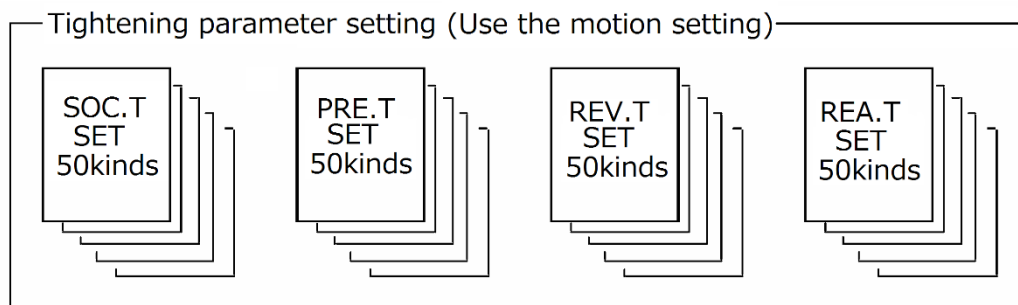
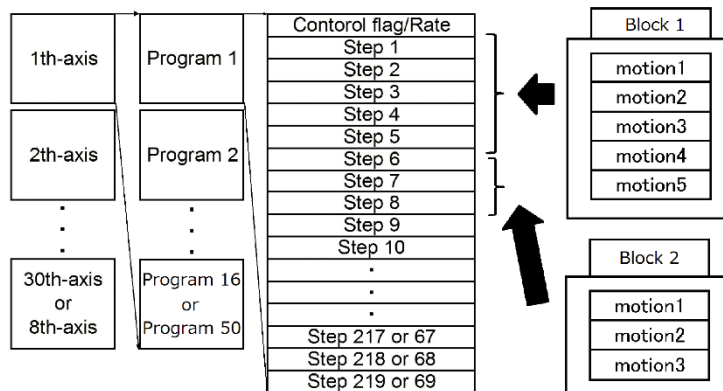

7. Setting function details

7-1 Fn.** display setting function list

It can set internal data and modify and monitor at the panel surface of the GSK controller.

Select data	Matter of display data	Remarks
Fn0-00	Status of 2-axis motion	Special display
Fn 0-01	I / O status	Display in the code the state of the DI and DO
Fn 0-02	Product Model	"021.0xx" xx is No. N upper two digits
Fn 0-03	Firm-ware program number	—
Fn 0-04	Firm-ware version number	—
Fn 0-05	At the hours, minutes, and seconds	It displays the current time
Fn 0-06	date	It displays the date
Fn 1-00~42	The first axis of the screw tightening result monitor	—
Fn 2-00~42	The second axis of the screw tightening result monitor	—
Fn 3-00~19	M-Net input / output monitor	Monitor the status of GSK-IF
Fn 4-00~01	Operation instruction from GSK controller	(Note 1)
Fn 5-01~30	Setting the unit number	(Note 1)
Fn 6-00~19	Setting of the I / F parameter	(Note 1)
Fn 7-00~03	Setting the ID controller	(Note 1)
Axx-yy	Parameter of the "SOC.T" operation	xx < 50 , yy < 16:(Note 1)
Lxx-yy	Parameter of the "PRET" operation	xx < 50 , yy < 32:(Note 1)
Gxx-yy	Parameter of the "REV.T" operation	xx < 50 , yy < 16:(Note 1)
Hxx-yy	Parameter of the "REA.T" operation	xx < 50 , yy < 48:(Note 1)
Uxx-yy	Parameter of the "RATE" operation	xx < 30 , yy < 10:(Note 1)
Xxx-yy	Parameter of the "X-axis RATE" operation	xx < 30 , yy < 16:(Note 1)
Yxx-yy	Parameter of the "Y-axis RATE" operation	xx < 30 , yy < 16:(Note 1)
Pu.xxx.y	XY position movement point coordinates	u : 1~4 xxx < 288 y < 2 (Note 2)
d0xxxx	Any data monitor of the 1th-axis	3 < xxxx ≤ 200: Can be changed (Note 3)
d1xxxx	Any data monitor of the 2th-axis	3 < xxxx ≤ 200: Can be changed (Note 3)
r0xxxx	The 1th axis of history data monitor	Address of FRAM , Data of 0xxxxh
r1xxxx	The 2th axis of history data monitor	Address of FRAM , Data of 1xxxxh

- ※ Note 1: When the data selection mode, the data sent to the controller in the long press "←".
- ※ Note 2: The u is a unit number, xxx is a point number, y = 0 is an X coordinate, y = 1 is a Y coordinate, and xxx > = 255 data is a limit coordinate data
- ※ Note 3: At time of data selection mode, it save the data of xxxx < 200 in the long press of the "←"

Axis number setting (d0xxxx)

GSK driver you need to set the the axis number (1 to 30 decimal) in order to identify each axis.

Please set the following parameters to manipulate the case of a two-axis for the driver panel.

In the case of Axis 1: Write to set the axis number to d00177. (Same as 1-axis type driver)

In the case of Axis 2: Write to set the axis number to d10177.

Please set so as not to overlap with the driver axis number.

Please set the axis number to 0 (not used) or, if you do not want to connect the motor in the two-axis type of driver.

7-2(d-00***, d-10***) Driver parameter setting for each axis

Here you can change the key parameter information of the driver amplifier.

Enter the following address numbers in the * part of (d-00 ***), and it switches to the input screen with the H / D button.

(Refer 6-1-2.)

Address	Name	Matter	Unit
036	Speed limit	This sets the maximum value of the rotational speed.	rpm
064	Method of return to origin	0: If you are detected using the LSW and the sensor 1: Collision formula	—
065	Set position data after the return to origin	Collision type: Home position return amount LSW type: Setting position after return to origin	—
066	Origin return start direction	Starting rotary direction of homing operation 0: positive direction 1: negative direction	—
068	Home position return speed	Home position return start speed	rpm
069	Creep rate	Home position detection speed	rpm
070	Collision time	Contact time in collision type origin detection	msec
071	Collision torque	Contact torque in collision type home position detection This is set as a percentage of motor rated current	%
084	Monitor 1 ID	Data of the set ID is converted to an analog signal and output from the M1 terminal	—
085	Monitor 1-scale	This sets the scale of the monitor 1 output.	—
086	Monitor 2 ID	Data of the set ID is converted to an analog signal and output from the M2 terminal	—
087	Monitor 2-scale	This sets the scale of the monitor 2 output.	—
104	Overload alarm detection current	If the average value of the motor current exceeds this setting, it outputs an overload alarm. This is set as a percentage of motor rated current.	%
105	Acceleration alarm detection speed	This outputs an acceleration alarm when the increase in rotational speed exceeds this set value.	rpm
114	RESOLVER_START_OFFSET	Since the resolver signal is an analog signal, a delay occurs before it is reflected in the operation. The start is delayed by this setting value so that the influence of the delay is reduced.	1/30 μ sec
140	Sensor type	GSK (W) -○○-E-N7 : 2 GSK (W) -○○-E1-N7 : 2 GSK (W) -○○-E2-N7 : 2 GSK (W) -○○-R-N7 : 8 GSK (W) -○○-E-P7 : 6 GSK (W) -○○-E-P7B : 7	—
141	Sensor resolution	GSK (W) -○○-E-N7 : 256 GSK (W) -○○-E1-N7 : 1024 GSK (W) -○○-E2-N7 : 2048 GSK (W) -○○-R-N7 : 8192 GSK (W) -○○-E-P7 : 16384 GSK (W) -○○-E-P7B : 16384	—
142	Sensor resolution magnification	GSK (W) -○○-E-N7 : 4 GSK (W) -○○-E1-N7 : 4 GSK (W) -○○-E2-N7 : 4 GSK (W) -○○-R-N7 : 1 GSK (W) -○○-E-P7 : 4 GSK (W) -○○-E-P7B : 4	—
144	Motor rated current	This shows the rated current of the connected motor. The ratio of the overload alarm detection current to the value displayed here is the overload alarm detection current threshold.	Arms
160	Gear abnormality determination count (continuous)	This sets the number of occurrences (accumulated or continuous) to determine as an alarm when a gear abnormality is detected	—
161	Gear abnormality determination count (cumulative)		
163	PRE.T tightening torque-free monitoring time	This sets the torque-free monitoring time of the PRE.T.	msec
165	Minimum slope judgment value	It is judged as abnormal when the slope is smaller than this setting value multiplied by -1.	%

Address	Name	Matter	Unit
166	Bolt fracture criterion value	This sets the sudden torque change rate that occurs at the end of PRE.T and REA.T as the judgment value of bolt breakage.	%
168	Polarity of tightening waveform	This reverses the output polarity of the entire waveform by selecting 1. ※ Please use when you select a left rotation.	—
169	Torque-free monitoring time	This sets the torque-free monitoring time in the case of the operation other than the REA.T and PRE.T.	msec
170	Zero magnification check wait time	This sets the waiting time until the torque signal is received after the zero magnification check signal is output	msec
174	Tightening angle sampling torque	This sets the torque value that is judged to be seated in the tightening angle measurement operation.	Nm
177	Axis number	You enter the axis number of each corresponding to the driver. ※Please set immediately after the driver mounting.	—
178	Axis type	This sets whether the axis of this driver amplifier is used as a nut runner or as a positioning motor. 1: Nut runner 2:X axis motor 3:Y axis motor ※This is set before operation check. Unlike axis number, it can be set by PC setting software.	—
179	Socket torque limit	This sets the current limit at socket removal operation (inching operation) by a percentage of the motor's rated current.	%
364	Motor average current	This is the effective value of the current flowing through the motor. An alarm is output when this current exceeds the current alarm threshold.	Arms
2003	Current position of angle sensor	This shows the current position of the angle sensor attached to the connecting motor.	—

※Important items

**177 (Axis number): Setting is required when the controller is installed in the equipment.
Be sure to set this when replacing or installing a new controller.**

7-3 SOC.T setting

It is the setting for performing screw tightening before the preparation operation. (Numbers 1 to 50)
 Bolt picked up, it performs a gear check, fitting, etc., and then to state that can be screw-tightening.
 Number is the number of the case to be set from GSK driver panel (Axx-yy)

No. (yy)	Matter	Unit
No.00	Angle This sets the end angle of this operation.	1 °
No.01	Speed This sets the rotational speed of this operation.	1rpm
No.02	Socket alignment operation/ Direction, Fitting, Gear checked 0 0 * □ +—— Socket fit/ Designation of rotational direction 0:Tightening direction 1:Loosing direction +—— Non torque check / Fitting/ Gear checked 0:Non torque check 1:One shot reverse 2:Fitting 3:Gear checked 4:Stop by external signal (Supported by controller version 1851-7.30 or higher)	—
No.03	Detection torque During the rotation, it reaches the set value, and exit the rotation. If you do not reach even beyond the cut angle will be the "fitting angle over".	0.1Nm
No.04	Before time This starts operation after the set time has elapsed from the socket alignment operation start.	1msec
No.05	Overtime If it is operating after the set time has passed from the socket alignment operation start, this ends the operation and outputs "overtime NG". (Not including before time)	1sec
No.06	Height check operation This sets whether to check the height and how many times to retry when it is done. The setting is made with 4 digits in hexadecimal (■ ■ □ □). High-order digit (■ ■): Height check 0: None 1: Yes. Lower digit (□ □): NG retry count 0 to 255 (FFh)	—
No.07	Upper limit of height check This is the height for retry judgment. Check the height of Z axis after executing socket alignment. And if the result is higher than this setting value, socket adjustment will be performed again.	0.1mm
No.08	Lower limit of height check This is the height for trial judgment. After executing socket alignment, check the height of Z axis. If the result is lower than this setting value, output NG immediately and advance to the next block.	0.1mm
No.09 ~ No.15	Unused	—

7-4 PRE.T setting

This setting is for rotating at high speed and moving the screw to the seating position. (No. 1 to 50)

The number is the number when setting from the GSK controller panel (Lxx-yy)

No. (yy)	Matter	Unit	
No.00	Rotation angle It sets the angle to rotate at the screw adjustment speed.	1 °	
No.01	1th speed It sets the rotation speed while turning at rotation angle.	1rpm	
No.02	Fast-forward angle It sets the rotation angle at the Fast-forward speed. After the rotation angle on screw adjustment is complete, this angle starts.	1 °	
No.03	2th speed It sets the rotation speed during the fast forward.	1rpm	
No.04	Closed fast decision torque If this torque is reached between the start and the end of the fast-forward angle, the fast-tightening judgment becomes invalid.	0.1Nm	
No.05	Pre-tightening torque It is the target torque of the pre-tightening.	0.1Nm	
No.06	Torque upper limit	If the torque value is not within the range at the time of stop, "Pre-tightening torque over" or " Pre-tightening torque under" NG is output.	0.1Nm
No.07	Torque lower limit		0.1Nm
No.08	End torque of 3th speed (upper byte) This torque switches to the 4th speed.	0.1Nm	
No.09	3th speed It is the speed before the screw is fastened after fast forward.	1rpm	
No.10	4th speed It is the final fastening speed of this process.	1rpm	
No.11	Over time If the pre-tightening torque is not reached from the start of this process until this set value, the rotation stops when this set time is reached and "over time" NG is output. This time setting prevents mistakes.	1sec	
No.12	Judgment area Judgment area in the graph of angle and torque, is the integral value of the torque waveform.	—	
No.13	Measurement invalid range This sets the range to disable the area measurement. The corresponding area will be from the pre-tightening start to this setting angle.	1 °	
No.14	Measurement angle The area is judged from the measurement start point to the set value.	1 °	
No.15	Before time This starts operation after the set time has elapsed from this operation start.	1msec	
No.16	Time upper limit	If the time value is not within the range at the time of stop, "Pre-tightening time over" or " Pre-tightening time under" NG is output.	1msec
No.17	Time lower limit		1msec
No.18	Angle upper limit	If the time value is not within the range at the time of stop, "Pre-tightening angle over" or " Pre-tightening angle under" NG is output.	0.1 °
No.19	Angle lower limit		0.1 °
No.20	Torque-free monitoring time This sets the time from the start of the pre-tightening until the start of torque monitoring. It does not measure the torque from the pre-tightening start until this set time. It is a setting to prevent misjudgment by picking up torque fluctuation at the start of rotation.	1msec	
No.21	Measurement start torque Measurement of tightening time and tightening angle starts after detection of the arrival at this set torque. If the torque does not reach this setpoint, the above time and angle will be the value from this motion start.	0.1Nm	

No. (yy)	Matter	Unit
No.22	Pre- tightening cut angle It stops when it reaches this set angle from measurement starting torque. This setting uses angles to prevent mistakes.	1 °
No.23	Unused	—
No.24	Speed 4 switching distance (for Z axis pressing control) When the current Z-axis coordinate reaches this value due to fast-forwarding, etc., the rotation speed is switched to speed 4.	0.1mm
No.25	Average torque before seating This is the upper limit set value for judging seizure torque. If the average torque between angles A and B before the stop torque exceeds the set value, the pre-tightening burn-in torque over NG. Supported with I/F version: 1899-7.015 or higher, controller version 1851-7.13 or higher.	0.1Nm
No.26	Angle A before stop torque Angle setting value for seizure torque judgment. Supported with I/F version: 1899-7.015 or higher, controller version 1851-7.13 or higher.	1 °
No.27	Angle B before stop torque Angle setting value for seizure torque judgment. Supported with I/F version: 1899-7.015 or higher, controller version 1851-7.13 or higher.	1 °
No.28	Upper total angle limit If the angle from the start of pre-tightening to the end of pre-tightening exceeds the set value, it will be NG. Supported with I/F version: 1899-7.031 or higher, controller version 1851-7.20 or higher.	1 °
No.29	Lower total angle limit If the angle from the start of pre-tightening to the end of pre-tightening is less than the set value, it will be NG. Supported with I/F version: 1899-7.031 or higher, controller version 1851-7.20 or higher.	1 °
No.30 ~ No.31	Unused	—

Pre-tightening reference waveform

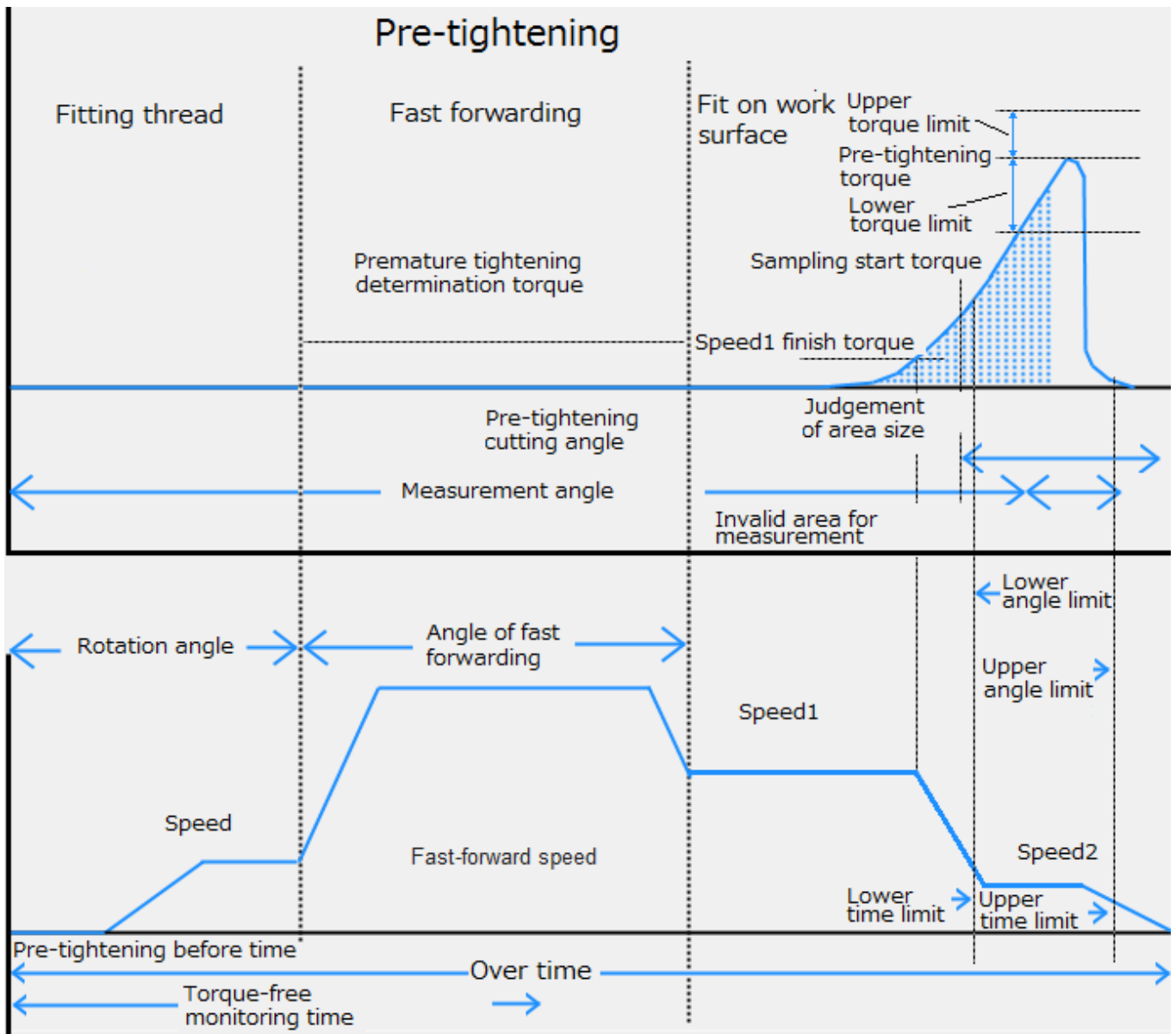

7-5 REV.T setting

You use the seating detection determined that the burning decision.

Number is the number of the case to be set from GSK driver panel (Gxx-yy).

No. (yy)	Matter	Unit
No.00	Judgment torque If this torque is exceeded when reaching the measurement angle, NG is output.	0.1Nm
No.01	Reverse angle This sets the angle to rotate in the reverse rotation.	1 °
No.02	The 1th speed This sets the 1th speed of reverse rotation. (Usually to a smaller value than the 2th speed)	1rpm
No.03	Measurement angle Before the end of the reverse rotation operation, torque judgment is performed when this set angle is reached. This sets the angle from the start of reverse rotation operation. Please set so that it becomes smaller than reverse rotation angle.	1 °
No.04	Passing torque If there is no condition beyond this set value during reverse rotation operation, "reverse rotation passing torque NG" will be obtained. (It becomes NG when tightening an unclamped bolt etc.)	0.1Nm
No.05	Baking torque When the torque reaches the set value during the reverse rotation process, it becomes "reverse seizing torque NG". It becomes NG when the pre-tightening torque is too large or when the screws are seized to not loosen.	0.1Nm
No.06	Overtime When this set time has elapsed from the start of reverse rotation, if it is in operation, it outputs NG and ends the operation. (Excluding before time)	1sec
No.07	Speed 1 End angle When this set angle is reached, the speed is switched from the first speed to the second speed.	1 °
No.08	The 2th speed It sets the reverse rotation second speed after removing the torque. (It is usually set to a value larger than the first speed)	1rpm
No.09	Before time This starts operation after the set time has elapsed from this operation start.	1msec
No.09 ~ No.15	Unused	—

Reverse tightening reference waveform

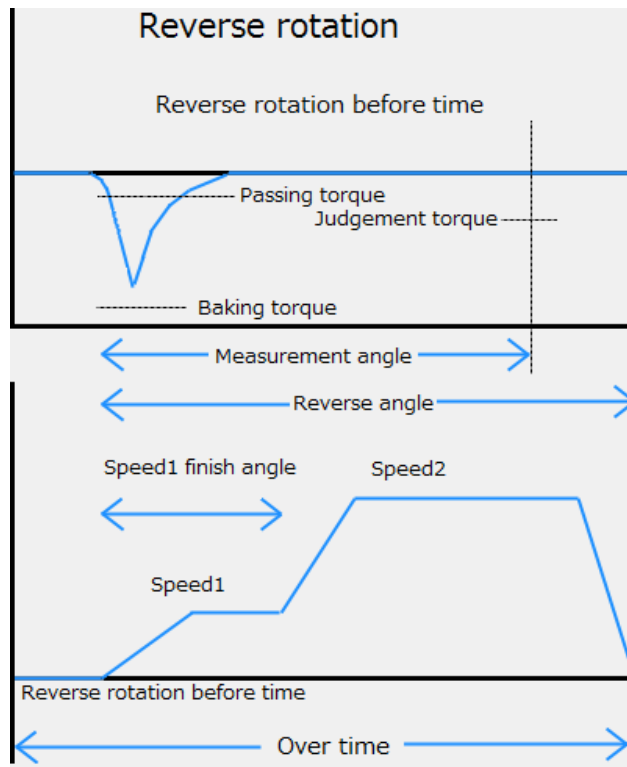

7-6 REA.T setting

It is set for a final tightening of the screws. (Numbers 1 to 50)

This tightening is selected from 4 types of torque mode / angle mode / Torque mode for nutrunner with clutch / Torque mode for nutrunner with clutch.

Method	Exit conditions
Torque mode	Until it reaches the cut torque, to rotate at a specified speed. Angle from the snug torque, to determine the time result.
Angle mode	From the snug torque, it will rotate at the specified speed until it reaches the cut angle. Torque, time, torque gradient also determined.
Torque mode for nutrunner with clutch	In addition to the normal torque mode, the return angle after tightening is monitored, and when the set angle returns, zero speed control (servo ON) is performed to force the return to stop. Supported with I/F version: 1899-7.043 or higher, controller version 1851-7.61 or higher.
Angle mode for nutrunner with clutch.	In addition to the normal angle mode, the return angle after tightening is monitored, and when the set angle returns, zero speed control (servo ON) is performed to force the return to stop. Supported with I/F version: 1899-7.043 or higher, controller version 1851-7.61 or higher.

Number is the number of the case to be set from GSK driver panel (Uxx-yy).

No. (yy)	Matter	Unit
No.00	Mode ★ (In GKL angle method can not be used) 0: Torque method 1: Angle method 4: Torque mode for nutrunner with clutch 5: Angle mode for nutrunner with clutch.	—
No.01	Torque method Real tightening torque: This torque is the target of this tightening.	0.1Nm
	Angle method Stop torque: It is a stop torque to prevent the bolt from twisting.	0.1Nm
No.02.	Torque method Measurement start torque ★: With this setting it begins measuring angle and time.	0.1Nm
	Angle method Snag torque: It starts clamping plastic zone from this torque. It also starts measuring angle and time.	0.1Nm
No.03	Speed 1 It is the speed at the start in this process. The tightening angle is also shown when tightening with only this process.	1rpm
No.04	Speed 1 End angle It rotates at speed 1 until this set angle is reached. When it reaches this angle, it switches to speed 2.	1 °
No.05	Speed 2 This is the tightening speed in this process.	1rpm
No.06	Over time: When this set time elapses from the start of the process, the process is terminated. It outputs overtime NG when it ends. (It is excluded from time).	1sec
No.07	Torque upper limit It sets the allowable upper limit of cut torque or stop torque.	0.1Nm
No.08	Torque lower limit It sets the allowable lower limit of cut torque or stop torque.	0.1Nm
No.09	Torque method Stop angle This is a setting to interrupt this process. It functions to not break the machine when the torque does not reach the target value due to some trouble.	1 °
	Angle method Tightening angle This is the rotation angle from the snug torque. This sets the target angle.	1 °
No.10	Before time: It delays the start of this process by the set value of time.	1msec

No. (yy)	Matter	Unit
No.11	Time upper limit It sets the allowable upper limit of the time. Unlike Overtime, this time is measured from the "measurement starting torque" or "Snag torque".	1msec
No.12	Time lower limit It sets the allowable lower limit of the time. Unlike Overtime, this time is measured from the "Measurement starting torque" or "Snag torque".	1msec
No.13	Angle upper limit It sets the allowable upper limit of the angle. Unlike Overtime, this time is measured from the "Measurement starting torque" or "Snag torque".	0.1 °
No.14	Angle lower limit It sets the allowable upper limit of the angle. Unlike Overtime, this time is measured from the "Measurement starting torque" or "Snag torque".	0.1 °
No.15	Closed fast decision angle: If the measurement start torque is detected earlier than this set angle, "fast-tightening NG" is output. In this case, fast-tightening refers to a state in which the screw hole is crushed and the screw is not tightened.	1 °
No.16	Torque-free monitoring time: It will not monitor the torque for the set time from the start of the process.	1msec
No.17	Judgment area Judgment area is in the graph of angle and torque. It is a setting for judging screw failure, and if it exceeds this value, it will be "screw failure". Please refer to the measured value in the online etc of the automatic measurement for the setting.	—
No.18	Torque method Unused	—
	Angle method Snag torque upper limit: It is the upper limit value of snug torque. If this value is exceeded, "snug torque over NG" is output.	0.1Nm
No.19	Torque method Zone judgment It sets whether to perform the zone judgment.	—
	Angle method Snag torque lower limit: It is the lower limit value of snug torque. If this value is exceeded, "snug torque under NG" is output.	0.1Nm
No.20	Torque method Zone judgment range It is one of the screw judgment. We select the range of zone judgment from the following. "No zone monitoring" ⇒ Zone judgment is not performed. "Zone lower limit ignored" ⇒ The lower limit value is not judged at zone judgment. "Zone upper limit ignored" ⇒ The upper limit value is not judged when zone judgment is made. "Zone normal monitoring" ⇒ Judge by the upper limit value and the lower limit value when judging the zone.	—
	Angle method REA.T passing torque: It is a torque to judge whether abnormality occurred during tightening. It is judged below this value after passing the snug torque.	0.1Nm
No.21	Torque method Zone starting point We set the torque value at the start of zone judgment.	0.1Nm
	Angle method Gradient decision: It sets whether to make gradient judgment. 0: None 1: Execution	—

No. (yy)	Matter		Unit
No.22	Torque method	Zone starting point tolerance We set the range of start torque for executing the zone judgment.	0.1Nm
	Angle method	Gradient sampling number: The width of one sampling is represented by this set value X 0.5 °.	1time
No.23	Torque method	Zone end point It sets the angle of judgment range at zone judgment.	0.1 °
	Angle method	Moving average number: It sets how many times sampling is done in increments of 0.5 °.	1 □
No.24	Torque method	Zone end point tolerance It sets the intersection angle of the end point for the zone judgment.	0.1 °
	Angle method	Gradient decision upper limit: It sets the upper limit value for gradient judgment.	1%
No.25	smoothing tightening It sets whether to perform smoothing tightening. 0:None 1: Execution		—
No.26	Initial speed It sets the speed at the start of smoothing tightening.		1rpm
No.27	Torque method	Cut torque at the speed It sets the speed at which the cut torque is reached during smoothing tightening.	1rpm
	Angle method	Snug torque speed: It sets the speed at which the snag torque is reached during smoothing tightening.	1rpm
No.28	Speed 3, 4 additional mode It sets whether to use Speed 3 and 4. 0:None 1: Execution		—
No.29	Speed 3 switching angle When this angle is reached, speed 3 is switched.		1 °
No.30	Speed 3 It will be the speed when you are seated in Speed 3, 4 mode.		1rpm
No.31	Speed 4 switching torque When this torque is reached it switches from Speed 3 to Speed 4.		0.1Nm
No.32	Speed 4 It is the final tightening speed in speed 3, 4 mode.		1rpm
No.33	Torque method	Stall time When the torque sensor is not used, it sets the time to hold the tightening torque in order to fix the torque.	1msec
	Angle method	Gradient decision lower limit: It sets the lower limit value for gradient judgment.	1%
No.34	Unused		—
No.35	Speed 4 switching distance (for Z axis pressing control) When the current Z-axis coordinate reaches this value due to fast-forwarding, etc. in the speed 3, 4 additional mode, the rotation speed is switched to speed 4.		0.1mm
No.36	Upper total angle limit If the angle from the start of final tightening to the end of final tightening exceeds the set value, it will be NG. Supported with I/F version: 1899-7.031 or higher, controller version 1851-7.20 or higher.		1 °
No.37	Lower total angle limit If the angle from the start of final tightening to the end of final tightening is less than the set value, it will be NG. Supported with I/F version: 1899-7.031 or higher, controller version 1851-7.20 or higher.		1 °
No.38	Return angle Set the return angle after tightening. When the set angle is reached, zero speed control (servo ON) is performed. Supported with I/F version: 1899-7.043 or higher, controller version 1851-7.61 or higher.		0.1 °
No.39	Zero speed control time Sets the time for zero speed control (servo ON). Supported with I/F version: 1899-7.043 or higher, controller version 1851-7.61 or higher.		1msec

No. (yy)	Matter	Unit
No.40	Soft Stop Start Torque Sets the torque at which soft stop begins. Set as a percentage (%) of the stopping torque. This setting can be used with controller version 1851-7.62 or higher.	1%
No.41	Soft Stop Time Sets the time from the soft stop start torque to the soft stop end torque. This setting can be used with controller version 1851-7.62 or higher.	1msec
No.42	Soft Stop Termination Torque Sets the torque at which soft stop is terminated. This setting can be used with controller version 1851-7.62 or higher.	0.1Nm
No.43	Retightening torque continuous detection time Addition of detection conditions for setting No. 1 final tightening torque. The final tightening torque is reached when the setting torque is continuously detected for a set period of time. ※The default setting is 0.	1msec
No.44 ~ No.47	Unused	—

※ Priorities of behavior is "with smoothing tightening"> "Speed 3, 4, additional mode"

Tightening wave and Zone judgement

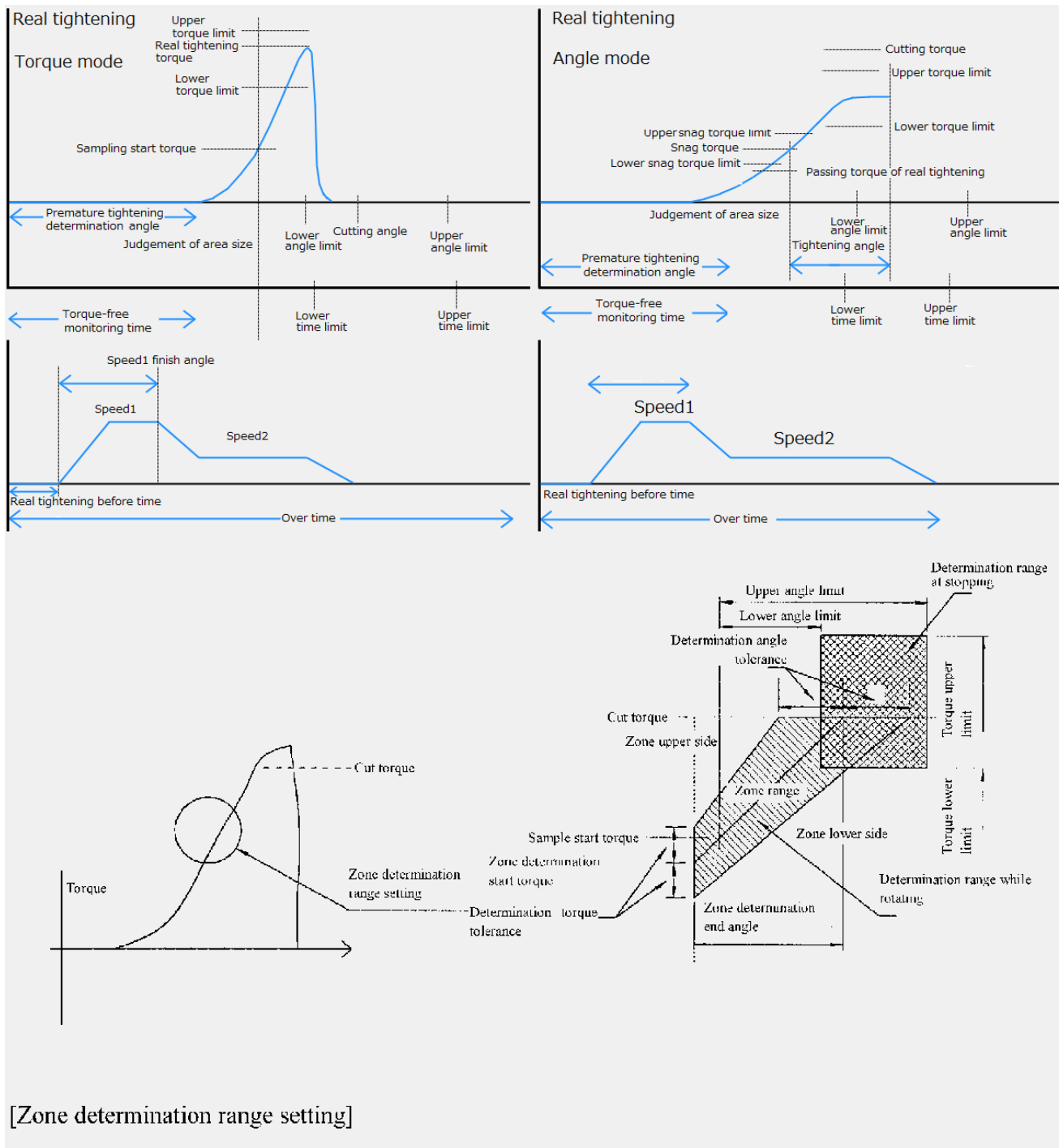

[Zone determination range setting]

ABOUT GRADIENT JUDGMENT

Setting items

- ① Gradient sampling number
- ② Moving average quantity
- ③ Gradient judgment value

Explanation of contents

- ① Gradient sampling number means the width of sampling per 1 time.
(Torque rising value at setting number x 0.5°)
- ② Moving average quantity means the number to get the data of width determined by the gradient sampling number at 0.5° interval.
- ③ Calculation method of gradient judgment value.
Setting value ≤ gradient at completion of real tightening / gradient right after snag torque x 100

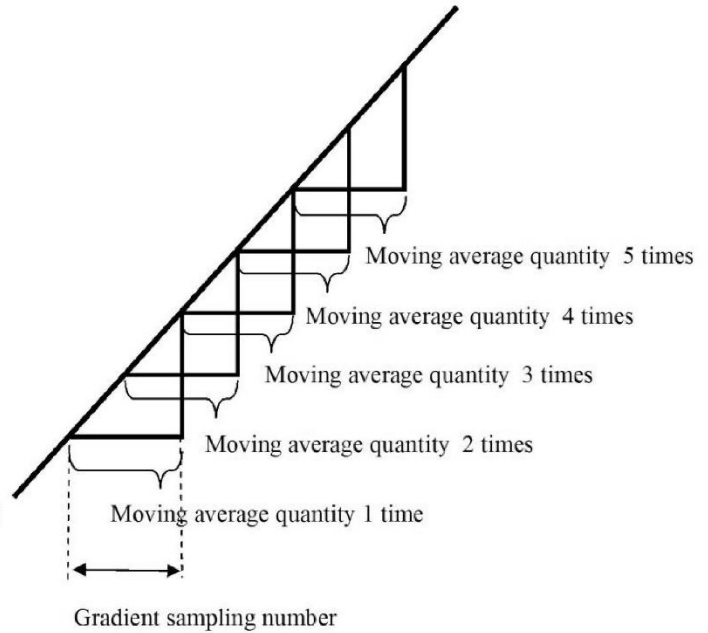

Example 1

(Based on tightening result said on right)

- Gradient sampling number (1)
- Moving average quantity (7)
- Gradient judgment value (70)

Gradient right after snag torque
(Initial gradient)

Q'ty	Angle	Torque rising value
1	0.0~0.5	1
2	0.5~1.0	1
3	1.0~1.5	1
4	1.5~2.0	1.5
5	2.0~2.5	1.5
6	2.5~3.0	1.5
7	3.0~3.5	1.5
Average value		1.285714286

Gradient at the completion of final tightening
(Completion gradient)

Q'ty	Angle	Torque rising value
1	12.5~13.0	0.3
2	13.0~13.5	0.2
3	13.5~14.0	0.2
4	14.0~14.5	0.2
5	14.5~15.0	0.2
6	15.0~15.5	0.1
7	15.5~16.0	0.1
Average value		0.185714286

Gradient value

$$0.186 \div 1.286 \times 100 = 14.46\%$$

Judgment becomes OK because of less than 70% of setting value in case of example 1 and example 2.

Example 2

(Based on tightening result said on right)

- Gradient sampling number (2)
- Moving average quantity (5)
- Gradient judgment value (70)

Gradient right after snag torque
(Initial gradient)

Q'ty	Angle	Torque rising value
1	0.0~1.0	2
2	0.5~1.5	2
3	1.0~2.0	2.5
4	1.5~2.5	3
5	2.0~3.0	3
Average value		2.5

Gradient at the completion of final tightening
(Completion gradient)

Q'ty	Angle	Torque rising value
1	13.0~14.0	0.4
2	13.5~14.5	0.4
3	14.0~15.0	0.4
4	14.5~15.5	0.3
5	15.0~16.0	0.2
Average value		0.34

Gradient value

$$0.34 \div 2.5 \times 100 = 13.6\%$$

Tightening result

Angle	Torque
0.0	40.0
0.5	41.0
1.0	42.0
1.5	43.0
2.0	44.5
2.5	46.0
3.0	47.5
3.5	49.0
4.0	50.5
4.5	51.5
5.0	52.5
5.5	53.5
6.0	55.0
6.5	56.5
7.0	58.0
7.5	59.0
8.0	60.0
8.5	60.5
9.0	61.0
9.5	61.5
10.0	62.0
10.5	62.5
11.0	63.0
11.5	63.3
12.0	63.6
12.5	63.9
13.0	64.2
13.5	64.4
14.0	64.6
14.5	64.8
15.0	65.0
15.5	65.1
16.0	65.2

7-7 Rate setting

It is the basic settings for the nut runner axis. (Number 1 to 30)

Please set a value corresponding to the motor and sensors to be used in the nut runner.

Number is the number of the case to be set from GSK driver panel (Uxx-yy).

No.	Matter	Unit								
No.00	Torque sensor rate/Current sensor rate <ul style="list-style-type: none"> • Torque sensor exist: Set the torque at the time of the torque sensor output 10V. • Torque sensor none: Set the nut runner shaft end torque of that which causes a momentary maximum current to the motor. 	0.1Nm								
No.01	Tightening direction/Nut runner format The following Bit allocation in hexadecimal data <table border="1" style="margin-left: 20px;"> <thead> <tr> <th>F</th> <th>E</th> <th>D~8</th> <th>7~0</th> </tr> </thead> <tbody> <tr> <td>0</td> <td>Tightening direction</td> <td>Sensor type (Note 2)</td> <td>Nut runner type (Note 1)</td> </tr> </tbody> </table> Tightening direction 0: Tightening in the right rotation looking at the motor from the encoder side. (tightening in the motor shaft end CCW rotation) 1: Tightening in the left rotation looking at the motor from the encoder side. (tightening in the motor shaft end CW rotation)	F	E	D~8	7~0	0	Tightening direction	Sensor type (Note 2)	Nut runner type (Note 1)	—
F	E	D~8	7~0							
0	Tightening direction	Sensor type (Note 2)	Nut runner type (Note 1)							
No.02	Limit over This sets the value variation tolerance for every zero magnification check. The output value in the previous zero-fold check is compared with the current output value. If the difference exceeds the set value, "zero offset fluctuation anomaly" and "multiplication fluctuation anomaly" will be generated respectively. (Torque sensor: about 2% of rated, current sensor: about 10% of rated)	0.1Nm								
No.03	Set over This sets the tolerance of the zero point output value and the magnification output value at the time of zero-magnification check. If the zero point output exceeds [(zero point preset) ± (set over)] or the magnification output exceeds [(magnification preset) ± (set over)], "zero offset error" or "magnification error" will occur. (About 5% of torque sensor rating, current sensor: about 20% of rating)	0.1Nm								
No.04	Zero preset This sets the output voltage without torque sensor load in terms of torque. Normally, this is set to "0".	0.1Nm								
No.05	Magnification preset This is set by converting the output voltage at torque sensor magnification check. Normally, it is set to 1/2 of the "torque sensor rating".	0.1Nm								
No.06	Gain correction This is used to correct the output (slope) of the torque (current) sensor. If not corrected, this item is set to 1/2 of the "Sensor rating". The corrected torque value is calculated by the following formula. $\text{Displayed torque value after correction} = \frac{\text{Sensor output voltage [V]}}{10 \text{ [V]}} \times \text{Sensor rated value [N}\cdot\text{m]} \times \frac{\text{Gain correction [N}\cdot\text{m]}}{\text{Magnification preset value [N}\cdot\text{m]}}$ The smaller the gain correction value, the higher the actual torque value.	0.1Nm								
No.07	Reduction ratio This sets the gear ratio of the nutrunner. Please set the mechanism to rotate once when the motor shaft rotates by the set value.	0.1rev								
No.08	Motor model (Note 3)	—								

(Note 1).About Nut runner type

Value	Nut runner type	remarks
0	OTHER	
1	ANZR (C) -1600	This setting can be used with controller version 1851-7.62 or higher.
2	ANZR (C) -2000	This setting can be used with controller version 1851-7.62 or higher.
3	ANZR (C) -3500	This setting can be used with controller version 1851-7.62 or higher.
4~10	—	
11	ANZMT-350UW	
12	ANZMT-500UW	
13	ANZMT-1600UW	
14	ANZMCH-200	
15	ANZMCH-450	
16	ANZMCH-900	
17	ANZMCH-1550	
18	ANZMCH-1850S	
19	ANZMCH-2001	
20	ANZR (C) -5000	
21	ANZR (C) -7000	
22	ANZR (C) -9000	
23	ANZR (C) -12000	
24	ANZM (C) -50E2	This setting can be used with controller version 1851-7.16 or higher.
25	ANZMCTH-450	
26	ANZMCXH-100E1	
27	ANZMCXH-150E1	
28	ANZMCXH-230E1	
29	ANZMCXH-450E1	
30	ANZMCXH-700E1	
31	ANZMCXH-900E1	
32	ANZM (C) -4800	
33	ANCKHM-200	
34	ANCKHM-300	
35	ANZM (C) -9001	
36	ANZM (C) -20000	
37	ANZM (C) -30	
38	ANZMH-200SFFT	
39	ANCKHM-500	
40~41	—	
42	ANZMKH-400	
43	ANZM (C) -250	
44	ANZM (C) -50	
45	ANZM (C) -350	
46	ANZMH-200	
47	ANZM (C) -500	
48	ANZM (C) -850	
49	ANZMH-450	
50	ANZM (C) -1600	
51	ANZM (C) -2000	
52	ANZMKH-700	
53	ANZM (C) -3000	
54	ANZMH-1500	
55	ANZM (C) -5000	
56	ANZM (C) -7000	
57	ANZM (C) -9000	
58	ANZM (C) -9000S	
59	ANZM (C) -4500	
60	ANZM (C) -15000	
61	ANZMH-1500	
62	ANZMH-900	
63	ANZM (C) -3500	
64	ANZMSH-700	

Value	Nut runner type	remarks
65	ANZMH-9000	
66	ANZMSH120E1	
67	ANZMH-2001	
68	ANZMSH-130	
69	ANZMSH-420	
70	ANZMH-1800S	
71	ANZMSH-2000	
72	AMZMH-2000	
73	ANZMSH-500	
74	ANZM (C) -1800S	
75	ANZM (C) -12000	
76~79	—	
80	ANZMKSH-40	
81~82	—	
83	ANZMSH-150	
84	LUR-1000	
85	ANZMCTH-100E1	
86	ANZMCTH-150E1	
87	ANZMCTH-230E1	
88	ANZMCTH-450E1	
89	ANZMCTH-700E1	
90	ANZMCTH-900E1	
91~92	—	
93	ANZMCH-2500	
94	ANZMSH-2001	
95	ANZMCTW-3500	
96	ANZMCH-2100	
97	ANZMC-40SFFT-E3	This setting can be used with controller version 1851-7.63 or higher.
98	ANZRCH-2500	
99	OTHER	

(Note 2).About sensor type

Value	Sensor type	remarks
0	Nothing	
1	100S	
2	200	
3	250	
4	350	
5	500	
6	850	
7	1500	
8	2500	
9	4000	
10	5000	
11	7000	
12	7500	
13	8000	
14	1200	
15	15000	
16	20000	
17	ANMSH-13	
18	AZM-40SH	
19	ANZMSH-70	
20	AZMT-150	
21	OTHER	
22	1850	
23	5500	
24	AZMC-51	

(Note 3).About motor model

Value	Motor type	remarks
0	TS4129N2820E230	
1~6	—	
7	TS4509N2825E203	
8	TS4515N2820E202	
9	TS4603N1920E203	
10	TS4603N1925E203	
11	TS4609N1920E203	
12	TS4612N6920E601	
13	TS4614N6920E102	
14	TS4617N1520E203	
15	TS4617N1920E203	
16	TS4618N1920E203	
17	TS4619N1920E203	
18	TS4619N1922E207	
19	TS4839N2820E235	
20	TS4617N1925E203	
21	TS4609N1925E203	
22	TS4618N1927E203	
23	TS4610N1625E206	
24	TS4619N1926E207	
25	TS4619N3326E207	
26	TS4603N1520E203	This setting can be used with controller version 1851-7.16 or higher.
27	TS4618N1922E203	This setting can be used with controller version 1851-7.17 or higher.
28	TS4618N3322E203	This setting can be used with controller version 1851-7.62 or higher.
29	TSM4104N7820E205	This setting can be used with controller version 1851-7.63 or higher.

7-8 X-axis rate setting

This is a basic setting for the X axis. (No. 1 to 30)

Please set the motor type and moving speed etc. used by the X axis.

X axis rating numbers 28 to 30 have special meanings.

- No. 28 is used by the manual JOG operation.
- No. 29 is used when the specified point and JOG start signal are input.
- No. 30 is used when the X return signal is input.

Number is the number of the case to be set from GSK driver panel (= xx-yy).

No. (yy)	Matter	Unit	
No.00	Acceleration time constant This sets the acceleration when moving the position.	10rpm/s	
No.01	Deceleration time constant This sets the deceleration when moving the position.	10rpm/s	
No.02	Moving Speed It set the movement speed at the time of position movement.	1mm/s	
No.03	Point ± detection range When the current coordinate is within the range "X-coordinate ± the set value of the points", GSK driver determines that the move to the specified point has been completed.	0.1mm	
No.04	Range output 1 lower limit	When the current X-axis coordinate is within the range of this setting, the output signal "X range output 1" will turn ON.	1mm
No.05	Range output 1 upper limit		
No.06	Range output 2 lower limit	When the current X-axis coordinate is within the range of this setting, the output signal "X range output 2" will turn ON.	1mm
No.07	Range output 2 upper limit		
No.08	Travel distance when the motor rotates once This sets the amount of movement when the motor makes one revolution.	0.001 mm/rev	
No.09	Motor model It is set the motor model. (See the motor model list(Note 1))	—	
No.10	Source direction of rotation When the position is increased in the positive direction, and set whether the motor is turning in any direction. 0000: CW direction as viewed from the rear of the motor 0001: CCW direction as viewed from the rear of the motor	—	
No.11	S-curve acceleration setting This is to set the acceleration / deceleration pattern of the positioning motor. [Bit15-12] acceleration / deceleration pattern 1 : Normal 2 : S-curve	—	
	[Bit11-0] S-curve acceleration time constant This sets the fluctuation range of acceleration / deceleration at S-curve control.	msec	

(Note 1) Motor model list

Value	Motor type	remarks
0~2	—	
3	TS4603	
4	TS4604	
5	TS4607N2088	
6	TS4609	
7	TS4607N3222	
8	—	
9	TS4612	
10	TS4610	
11	TS4606	
12	TS4612N3222	
13	TS4613N3222	
14	TS4614N6920	
15	TSM4104N2820	
16	TSM4104N7820	
17	TSMB	
18	TSM	
19	TS4602N7032E200	This setting can be used with controller version 1851-7.11 or higher.
20	TS4602N8000E200	
21	TS4603N8000E200	
22	TSM4204N7820E205	This setting can be used with controller version 1851-7.15 or higher.
23	TSM4354N2802E200	This setting can be used with controller version 1851-7.26 or higher.
24	TSM4354N7802E200	This setting can be used with controller version 1851-7.26 or higher.
25	TSM4254N2820E200	This setting can be used with controller version 1851-7.31 or higher.

7-9 Y-axis rate setting

This is a basic setting for the Y axis. (No. 1 to 30)

Please set the motor type and moving speed etc. used by the Y axis.

Y axis rating numbers 28 to 30 have special meanings.

- No. 28 is used by the manual JOG operation.
- No. 29 is used when the specified point and JOG start signal are input.
- No. 30 is used when the Y return signal is input.

Number is the number of the case to be set from GSK driver panel (= xx-yy).

No. (yy)	Matter	Unit	
No.00	Acceleration time constant This sets the acceleration when moving the position.	10rpm/s	
No.01	Deceleration time constant This sets the deceleration when moving the position.	10rpm/s	
No.02	Moving Speed It set the movement speed at the time of position movement.	1mm/s	
No.03	Point ± detection range When the current coordinate is within the range "X-coordinate ± the set value of the points", GSK driver determines that the move to the specified point has been completed.	0.1mm	
No.04	Range output 1 lower limit	When the current Y-axis coordinate is within the range of this setting, the output signal "Y range output 1" will turn ON.	1mm
No.05	Range output 1 upper limit		
No.06	Range output 2 lower limit	When the current Y-axis coordinate is within the range of this setting, the output signal "Y range output 2" will turn ON.	1mm
No.07	Range output 2 upper limit		
No.08	Travel distance when the motor rotates once This sets the amount of movement when the motor makes one revolution.	0.001 mm/rev	
No.09	Motor model It is set the motor model. (Same as X-axis rating)	—	
No.10	Source direction of rotation When the position is increased in the positive direction, and set whether the motor is turning in any direction. 0000: CW direction as viewed from the rear of the motor 0001: CCW direction as viewed from the rear of the motor	—	
No.11	S-curve acceleration setting This is to set the acceleration / deceleration pattern of the positioning motor. [Bit15-12] acceleration / deceleration pattern 1 : Normal 2 : S-curve	—	
	[Bit11-0] S-curve acceleration time constant This sets the fluctuation range of acceleration / deceleration at S-curve control.	msec	

7–10 Point seting

It will remember the XY coordinates of each unit in the form of a point number.

If GSKIF instructs the move to GSK driver, specify the point number, not the coordinate value.

Number is the number of the case to be set from GSK driver panel (= x-yyy-z).

The x is the unit number (1 ~ 4), yyy is point number (1 ~ 255), z indicates the axis type.

No. (yy)	Matter	Unit
No.000 ~ No.254	Point coordinate value (point number 1 to 255) : It sets the coordinate value of the point of X (or Y) axis to here. ※ As for axis type, 0 is X axis and 1 is Y axis.	0.1mm
No.255 ~ No.256	Unused	—
No.257	It sets the coordinate value of the upper limit in the operation according to the unit number and axis type etc.	—
No.258 ~ No.267	Unused	—
No.268	It sets the coordinate value of the lower limit in the operation according to the unit number and axis type etc.	—
No.269 ~ No.287	Unused	—

7-11 (Fn. 01) Tightening result monitor of 1st axis

No.	Matter
Fn.1-00~42	This displays the tightening result of the first axis.

This function is for confirmation only.

Please note that the content can not be changed.

7-12 (Fn. 02) Tightening result monitor of the 2nd axis

No.	Matter
Fn.2-00~42	This displays the tightening result of the second axis.

This function is for confirmation only.

Please note that the content can not be changed.

※Fn.1 および Fn.2 の表示内容

In Fn1-xx and Fn2-xx in the data selection mode, you can check the data on screw tightening of CH1 and CH2.
The following table shows the display contents for the above xx numbers.

縮付データ

No. (xx)	Contents
00	Screw number
01	Program number
02	The torque results of socket alignment operating
03	The time results of socket alignment operating
04	The angle results of socket alignment operating
05	The torque results of pre-tightening operation
06	The time results of pre-tightening operation
07	The angle results of pre-tightening operation
08	The torque results of final tightening operation
09	The time results of final tightening operation
10	The angle results of final tightening operation
11	The sample point torque of final tightening operation
12	The final slope ratio of final tightening operation
13	Unused
14	The torque results of reverse operation
15	The time results of reverse operation
16	The angle results of reverse operation
17	Result number
18	The fast-forward torque result of pre-tightening
19	The fast-forward time result of pre-tightening
20	The fast-forward angle result of pre-tightening
21	The area result of pre-tightening
22	The area result of final tightening
23	The initial slope of the final tightening
24	The final slope of the final tightening
25	The gradient ratio of t final tightening $((23) / (24) \times 100)$
26	The sample point torque result of pre-tightening
27	The total operating time result of the pre-tightening operation
28	The total rotation angle result of the pre-tightening operation
29	The total operating time result of the final tightening operation
30	The total rotation angle result of the final tightening operation
31	The sample point angle result of the reverse rotation
32	The execution time of the program operation
33	Unused
34	Unused
35	The offset torque result of zero magnification check operation
36	Zero preset value of the "rate" parameter
37	The test of the zero magnification check operation
38	The gain correction value of the "rate" parameter
39	The number of running the program operation
40	Position data of the motor [2048/rev]
41	The A / D input value of the torque sensor [2048/10V]
42	(Parameter)typical value of torque sensor preset

You can update the displayed data by pressing and holding the “◀” button for 2 seconds.

7-13 (Fn. 03) Input / output monitor

The displayed content changes according to the value specified in "PLC signal monitor unit" of Fn 6-05 IF parameter.
The display format is fixed to 2 hexadecimal digits.

【When monitor unit = 1 to 6】

This monitors the PLC (including M-NET) signal of the specified unit number.

Data No.	Data display contents	Remarks
Fn3-00~07	Input signal monitor from PLC	This displays the first 8 bytes of the unit input signal. The display will be "00" as 05-07 is an unused area.
Fn3-08~15	Output signal monitor to PLC	This displays the first 8 bytes of the unit output signal.
Fn3-16	Active block number	—
Fn3-17	Operating state 1 of each axis (Nut runner, Z axis state)	Bit7 : Z-axis Not Ready※This is turned on by driving power off etc. Bit6 : Z-axis Operation NG Bit5 : Z-axis In rotation Bit4 : Z-axis In action Bit3 : NR-axis Not Ready Bit2 : NR-axis Operation NG Bit1 : NR-axis In rotation Bit0 : NR-axis In action 【When multiple mode】 If one axis is ON, this indication is ON.
Fn3-18	Operating state 2 of each axis (X-axis and Y-axis state)	Bit7 : Y-axis Not Ready Bit6 : Y-axis Operation NG Bit5 : Y-axis In rotation Bit4 : Y-axis In action Bit3 : X-axis Not Ready Bit2 : X-axis Operation NG Bit1 : X-axis In rotation Bit0 : X-axis In action
Fn3-19	Operating state 3 of each axis (Z axis state (position))	Bit7-6 : Fixed to 0 Bit5 : Z-axis position is the down limit (same as output signal "Z-axis position 2") Bit4 : Z-axis position is the upper limit (same as output signal "Z-axis position 1") Bit3-2 : Fixed to 0 Bit1-0 : Z-axis pressing condition (0: OFF 1 to 3: pressing force during operation)

【Monitor unit = 0】

This monitors the internal state of GSK interface.

※ All indication is hexadecimal number.

No.	Matter																																													
Fn3-No0~3	2 digits display IP address of GSKIF of the board for FTP transfer “<No0>. <No1>. <No2>. <No3>” ※If you set the IP address to "0.0.0.0" in the FTP network settings, the IP address stored inside the Anybs board will be displayed.																																													
Fn3-No4~7	2 digits display IP address of FTP server (transfer destination) “<No 4>. <No 5>. <No 6>. <No 7>”																																													
Fn3- No8~11	2 digits display IP address of GSKIF of board for PLC connection (for PROFINET or EtherNet / IP) “<No8>.<No9>.<No10>.<No11>” ※If you set the IP address to "0.0.0.0" in the FTP network settings, the IP address stored inside the Anybs board will be displayed.																																													
Fn3-No12	2 digits display FTP status display																																													
	<table border="1"> <thead> <tr> <th>Value</th> <th>Upper (Last FTP transfer result)</th> <th>lower (Current FTP transfer status)</th> </tr> </thead> <tbody> <tr> <td>0</td> <td>Initial state</td> <td>Initial state</td> </tr> <tr> <td>1</td> <td>OK FTP Transfer successful</td> <td>Waiting for retry start</td> </tr> <tr> <td>2</td> <td>NG FTP Start process</td> <td>FTP During start processing</td> </tr> <tr> <td>3</td> <td>NG FTP SERVER CONNECT</td> <td>Connecting to FTP server</td> </tr> <tr> <td>4</td> <td>NG USER COMMAND</td> <td>During USER command execution</td> </tr> <tr> <td>5</td> <td>NG PASS COMMAND</td> <td>During PASS command execution</td> </tr> <tr> <td>6</td> <td>NG TYPE COMMAND</td> <td>During TYPE command execution</td> </tr> <tr> <td>7</td> <td>NG CWD COMMAND</td> <td>During CWD command execution</td> </tr> <tr> <td>8</td> <td>NG PASV COMMAND</td> <td>During PASV command execution</td> </tr> <tr> <td>9</td> <td>NG STOR COMMAND</td> <td>During STOR command execution</td> </tr> <tr> <td>A</td> <td>NG DATA CONNECT</td> <td>During data access</td> </tr> <tr> <td>B</td> <td>NG DATA TRANSFER</td> <td>During data transfer</td> </tr> <tr> <td>C</td> <td>NG FTP CLOSE</td> <td>Exiting FTP</td> </tr> <tr> <td>D-F</td> <td>Unused</td> <td>Unused</td> </tr> </tbody> </table>	Value	Upper (Last FTP transfer result)	lower (Current FTP transfer status)	0	Initial state	Initial state	1	OK FTP Transfer successful	Waiting for retry start	2	NG FTP Start process	FTP During start processing	3	NG FTP SERVER CONNECT	Connecting to FTP server	4	NG USER COMMAND	During USER command execution	5	NG PASS COMMAND	During PASS command execution	6	NG TYPE COMMAND	During TYPE command execution	7	NG CWD COMMAND	During CWD command execution	8	NG PASV COMMAND	During PASV command execution	9	NG STOR COMMAND	During STOR command execution	A	NG DATA CONNECT	During data access	B	NG DATA TRANSFER	During data transfer	C	NG FTP CLOSE	Exiting FTP	D-F	Unused	Unused
	Value	Upper (Last FTP transfer result)	lower (Current FTP transfer status)																																											
	0	Initial state	Initial state																																											
	1	OK FTP Transfer successful	Waiting for retry start																																											
	2	NG FTP Start process	FTP During start processing																																											
	3	NG FTP SERVER CONNECT	Connecting to FTP server																																											
	4	NG USER COMMAND	During USER command execution																																											
	5	NG PASS COMMAND	During PASS command execution																																											
	6	NG TYPE COMMAND	During TYPE command execution																																											
	7	NG CWD COMMAND	During CWD command execution																																											
	8	NG PASV COMMAND	During PASV command execution																																											
	9	NG STOR COMMAND	During STOR command execution																																											
	A	NG DATA CONNECT	During data access																																											
B	NG DATA TRANSFER	During data transfer																																												
C	NG FTP CLOSE	Exiting FTP																																												
D-F	Unused	Unused																																												
	<p>【Meaning of result】 0: FTP transfer has not been performed even once after power on 1: FTP transfer succeeded 2-3: Could not connect to the FTP server. (LAN cable disconnection, address error etc.) 4 or more: Failed to connect to the FTP server. (Incorrect password etc.)</p>																																													
Fn3-No13	Unused																																													
Fn3-No14	IF alarm detail code (upper)																																													
Fn3-No15	IF alarm detail code (lower)																																													
~Fn3- No19	Unused																																													

7-14 (Fn. 04) Operation instruction from GSK controller

The Fn.4 writing operation is an operation command for GSK interface.

This performs the following operation by setting the operation type to Fn4-00 and the data number to Fn4-01 and pressing the ← button for a long time.

No.	Matter	Commentary
Fn4-00	Operation type	1: REA.T result print start 2: Special operation 3: FTP transfer test
Fn4-01	Data number	[When operation type = 1] Unit number (1 to 7). [For operation type = 2] Special operation for debugging 1: SETTING. BIN file save (GSKIF ⇒ SD) [When operation type = 3] This performs FTP transfer test.

7-15 (Fn. 05) Unit setting

This sets the relationship between unit number and axis.

The number indicates the axis number (1 to 30).

No.	Matter
Fn5.-□□	It is 2-byte data of hexadecimal . [Bit15-8]Unit number (1 to7, 0 is not connected) [Bit7-0]Axis type (0: None 1: Nut runner 2: X axis 3: Y axis 4: Z axis)

【Note】

After changing the unit settings, it is necessary to power off GSK-IF once.

The GSK system does not activate unit configuration changes unless the power is turned off.

The unit settings have the following limitations.

- Specify the axes in ascending order of UNIT number.
⇒ Axis 1 / UNIT1, Axis 2 / UNIT1, Axis 3 / UNIT2 are OK.
⇒ Axis 1 / UNIT1, Axis 2 / UNIT2, Axis 3 / UNIT1 are NG.
 - Specify the axes in the same unit by order of NR / X / Y / Z.
⇒ Axis 1 / UNIT1 (NR), axis 2 / UNIT1 (X), and axis 3 / UNIT1 (Z) are OK.
⇒ Axis 1 / UNIT1 (NR), axis 2 / UNIT1 (Z), and axis 3 / UNIT1 (X) are NG.
- ※ It is possible to skip an unused axis and specify.
Axis 1 / UNIT1, Axis 2 / Not connected, Axis 3 / UNIT1 are OK.

7-16 (Fn. 06) Interface unit setting

No. (yy)	Matter	Unit																
No.00	<p>Basic setting</p> <table border="1" data-bbox="252 271 1225 338"> <tr> <td>Bit7</td><td>Bit6</td><td>Bit5</td><td>Bit4</td><td>Bit3</td><td>Bit2</td><td>Bit1</td><td>Bit0</td> </tr> <tr> <td>Reserve</td><td>Reserve</td><td>Reserve</td><td>Reserve</td><td>Reserve</td><td>Reserve</td><td>IOB2</td><td>SYS</td> </tr> </table> <p>[Bit0] System GSK operation 0: Standard GSK (connect PLC) 1: System GSK (Unused PLC) [Bit1] Whether to use 2 I/O boards in system GSK 0: Not used(CN14 connector only) 1: Use(CN13/CN14 connector) [Bit2-7] Reserve</p>	Bit7	Bit6	Bit5	Bit4	Bit3	Bit2	Bit1	Bit0	Reserve	Reserve	Reserve	Reserve	Reserve	Reserve	IOB2	SYS	—
Bit7	Bit6	Bit5	Bit4	Bit3	Bit2	Bit1	Bit0											
Reserve	Reserve	Reserve	Reserve	Reserve	Reserve	IOB2	SYS											
No.01	<p>[Quality control PC waveform reading maximum waiting time] 【In case of multi-axis mode】 This setting has no meaning 【Other than multi-axis mode】 This sets the maximum waiting time for loading the waveform on the quality control PC. The quality control PC reads the waveform at the end of the block, but it takes time to read the waveform. It is a timer value for holding so as not to advance to the next block in the meantime. 1 to 9: Waiting time, 0: Quality control PC disabled</p> <p>[Operation when waiting time is 1 or more] This suspends the execution of the next block until the waveform reading of all units by the personal computer is completed at the end of the block. ⇒ Execution of the next block starts when all waveform reading is completed. In this case, the next block is started earlier than the waiting time. ⇒ If the wait time is reached and waveform reading of all units has not been completed yet, execution of the next block starts.</p> <p>※ Although this setting is for the quality control PC, the same operation is performed when the setting PC is connected. If you do not connect the quality control PC, be sure to set 0.</p>	sec																
No.02	<p>Screw number for ID output It sets the maximum number of for a single work when the connected ID controller is T type.</p>	—																
No.03	<p>This sets the communication speed of the personal computer (1 byte data of hexadecimal) communication speed of setting personal computer (bps) 0:9600 1:19200 2:38400 communication speed of quality control personal computer (bps) 0:19200 1:38400</p>	—																
No.04	<p>Setting of the external display (Decimal data) 1th digit: Display valid (0: Invalid 1: Valid) 2th digit: Language switching (0: Japanese 1: English) ※ Language will be changed by sending the information of the language switching to an external display.</p>	—																
No.05	<p>M-NET signal monitor unit selection This select the unit number (1 to 7) to be displayed in GSK driver panel according to the M-NET signal monitor (Fn03). If set to 0 will be the state monitoring of GSK interface.</p>	—																
No.06	<p>Waveform resolution to an external display The resolution of the waveform data when transmitted to an external display in 0.5-degree increments. (For example, 0.5 degrees: 05, 1.0 degrees: 10, 1.5 degrees: 15, 2.0 degrees: 20)</p>	0.1degree																

No. (yy)	Matter	Unit	
No.14	[Parameters for Special Equipment]	—	
	Value of No.13		Meaning
	1(Special equipment 1)		Unused
	2(Special equipment 2)		A special unit that moves the position in the setting of the nutrunner is specified in Bit (Bit0 = UNIT1, bit1 = UNIT2, ..., Bit6 = UNIT7)
No.15	<p>PLC setting 2 Extended setting for PLC operation [In the case of MNET] It is fixed to 0. (This setting does not have meaning) [In case of PLC using Aybus board] GSK operation differs depending on the type of board to be connected. For details, please refer to the specifications for each communication method.</p>	sec	
No.16	<p>This is two-digit data in hexadecimal. Upper digit: [Bit 7-6] Spare [Bit 5] Restart after cycle stop(0: prohibited 1: permitted) [Bit 4] Block at restart (0: Operate the same block 1: Go to the next block)</p> <p>Lower digit [Bit3-0]: Adjustment mode speed The XYZ axes operate at the specified speed x 10%. (1 runs at 10% speed) It operates at 30% when 0, and 100% when A to F (10 or more).</p>	— [10%]	
No.17 ~ No.19	Unused		

※When changing the IF parameter, turn off the power once and then operate it.

7-17 (Fn. 07) ID connection setting

Number	Matter
No. 0	ID controller output content setting
No. 1	ID controller output content setting
No. 2	ID controller output content setting
No. 3	M-Net start address setting " set at the 1-7 "

Please refer to the following about the details of the above-mentioned Fn.7.

No.	Digit	Setting Value	Matter
No._00	1 st digit	0	Data transmission at block judgement output
		1	Data transmission at start of next block and input of judgement reset input
		2	Data transmission from command from the upper device
		Min.3	Not used
	2 nd digit	0~7	This sets the engine number transmission digit number. 0: None , 1 to 7: Number digit transmission
	3 rd digit	0 / 1	Transmission setting of screw number 0: Do not send 1: Send
	4 th digit	0 / 1	Transmission setting of each axis judgment 0: Do not send 1: Send
No._01	1 st digit	(Note 1)	This sets the digit no. of transmission with torque.
	2 nd digit		This sets the digit no. of transmission with time.
	3 rd digit		This sets the digit no. of transmission with angle.
	4 th digit		This sets the digit no. of transmission with slope(snag torque).
No._02	1 st digit	0 ~ 4	I / F unit ID controller / printer function selection 0: Printer connection (ID controller not connected) 1: Standard specification ID controller connection 2: Toyota specification ID controller (torque and judgment output) 3: Toyota specification ID controller (judgment output) 4: Jatco specification ID controller connection 5: Free (not used) 6: A specification ID controller connection When using JTECT's display, please set it to any ID controller connection.
	2 nd digit	0 / 1	This sets Yes or No with transmission of date and time 0: not to be transmitted 1: to be transmitted
	3 rd digit	0 / 1	This sets Yes or No with transmission of program no. 0: not to be transmitted 1: to be transmitted
	4 th digit	0 ~7	Unit number other transmission setting Bit 0: Unit number sent / not sent 0: None 1: Present Bit 1: Selection of slope / SNAG 0: Slope: 1SNAG Bit 2: Selection of torque value 0: Torque according to priority 1: SNAG torque fixed
No._03	—	1~7	M-NET station address setting This sets the station address of unit 1. The address after unit 2 is the serial number from the setting value +1. Set the final station to 7 or less. Example: When the set value is 6, unit 1: station 6, unit 2: station 7. (In this example, units 3 and 4 can not correspond)

(Note 1) Transmission digit setting list

Setting value	Torque, Angle, Slope	Time	Remarks
0	Not send		
2	*. *	*. *	2 digits with decimal point
3	**.*	*. **	3 digits with decimal point
4	***.*	*. ***	4 digits with decimal point
5	****.*	*. ****	5 digits with decimal point
6	*****.*	*. *****	6 digits with decimal point
A	**	**	2 digits without decimal point
B	***	***	3 digits without decimal point
C	****	****	4 digits without decimal point
D	*****	*****	5 digits without decimal point
E	*****	*****	6 digits without decimal point

If the setting value is not specified above, it will be the same operation as 0.

7-18 About Z axis setting

7-18-1 Coordinate setting of Z axis

The coordinates of the Z axis are set in setting No. 160 to 239 (XY point No. 161 to 240) of point setting.

Therefore, the points when using the Z axis are only point numbers 1 to 160 and four original positions.

The value set here indicates the descent amount in units of 0.1 mm when the "Cylinder operation" command is executed.

No. (yyy)	Contents	Setting range	Unit
No.160 ~ No.239	7SEG display = Px (unit number). Yyy (setting number) . Z (axis type 0: X coordinate, 1: Y coordinate). If this is easy to see, it will be the following. Z coordinate of point No. 1 at Px.160.0. Z coordinate of point No. 2 at Px.160.1. Z coordinate of point No. 3 at Px.161.0 Z coordinate of point No. 4 at Px.161.1 . . . Z coordinate of point No. 159 at Px.239.0 Z coordinate of point No. 160 at Px.239.1 It sets the point coordinates of the Z axis in the above manner.	0000-9999	0.1mm

7-18-2 Z axis rate setting

When using a Z axis motor, the setting No. 240 to 250 of the point setting is the setting area of the Z axis rating.

Unlike X-axis and Y-axis ratings, Z-axis ratings are fixed for each unit.

It is not possible to change the rating number during automatic operation.

No.		Item	Explanation	Unit	Maximum value
yyy	z				
240	0	Acceleration rating	Z axis acceleration	10rpm/sec	32767
	1	Deceleration rating	Z axis deceleration	10rpm/sec	32767
241	0	Travel distance per motor	Length traveled by one motor revolution	0.1mm/rev	32.767
	1	Source rotation direction	Motor rotation direction when moving in + direction ※ 0 origin on the motor side is CCW	0 : CW 1 : CCW	
242	0	Moving Speed	Travel distance per second	1mm/sec	
	1	Return amount (relative distance)	Movement amount when moving up with "Cylinder relative return" command	0.1mm	
243	0	Return position (Rising limit)	Position when raising the Z-axis by return operation and "Cylinder return" command	0.1mm	
	1	Lower limit	Abnormality judgment value at Z axis movement Alarm is generated when moving above specified value	0.1mm	
244	0	Point detection coordinates	Check range of whether the Z axis is within the target range	1mm	100
	1	Unused	Reserve	—	
245	0	JOG Speed	JOG operation speed	1mm/sec	
	1	Home return operation speed	Home return operation speed	1mm/sec	
246	0	Driver type	Type of driver to connect	0:GSK driver amplifier	
	1	Motor type	Specify motor type	X axis rating table Refer motor type	
247	0	Z_UP 1 coordinate	Coordinates ascended by Z_UP 1 command	0.1mm	
	1	Z_UP 2 coordinate	Coordinates ascended by Z_UP 2 command	0.1mm	
248	0	Z axis overlap distance	Upper byte: Lowering completion overlap distance Lower byte: Rise completion overlap distance	1mm	
	1	XY axis overlap distance	Upper byte: spare Lower byte: XY movement completion overlap distance	1mm	
249	0	Z range upper limit position	Upper limit coordinate (minimum value) of Z range output signal	0.1mm	
	1	Z range lower limit position	Lower limit coordinate of Z range output signal (maximum value)	0.1mm	
250	—	Unused	—	—	

8. Supplementary explanation

8-1 Motion assist function

①Zero-magnification check function

If the check box in the program setting is checked, zero magnification check will be performed.

If it is not present, this check will not be performed.

This check is always performed in multi-axis mode.

In positioning mode, it is executed only at the first tightening block.

②History data storage function

After tightening comprehensive judgment outputs, it makes the history data stored in each driver at the reset input as a trigger.

When the data is confirmed the data was read from the setting software-automatic measurement screen. -

(The history data is read to PC by the all or Specified axis when the read switch on setting software.

There is the cancel SW.)

③Waveform sampling function

It can save 2048 the 2 kinds of waveform data in the each driver.

2 kinds of waveform data are called waveform data 1 and waveform data 2.

When the number of data is over 2048, next tightening data will be overwritten.

Waveform data1: save in 10msec Interval from the block start to block end.

Waveform data2: save in 0.5degree Interval from the real tightening snag torque to real tightening finished

It is possible at the setting software that it saves the waveform data 1 after tightening

and it can get waveform data 2 by the always-on connection (online).

8-2 Driver function

Regeneration capability: If the drive voltage exceeds a certain value, it has a built-in regenerative circuit to be consumed by the internal resistance. (Regenerative resistor is external.)

Discharge function: The driver spontaneously discharges by the LED.

Analog monitor: Monitor signal output from the panel surface check pin (can be selected by parameter)

Standard load inertia : $JL(\text{Standard load inertia}) \leq 30JM(30 \text{ times of the moter inertia})$

Tightening history storage: GSK saves approximately 5000 tightening data in the E2PROM of each driver amplifier.

Setting software is used to read the history.

Alarm history function:GSK stores 16 alarms for each driver amplifier.

Setting software is required to read alarm history.

9. Monitor output

Any internal signal of this driver is converted into an analog signal of $-8V \sim +8V$, it can be monitored.

The output voltage is scaled so that the setting value of the monitor output scale become 8V.

The analog monitor signal is output to M1.M2 pin on the panel surface of the driver.

The setting about an analog monitor is indicated below.

Please input the address in d_00XXX.

There are the pins of M1, M2 only on CH1 side in case of GSKW.

When seeing CH2 side, please change the input ID.

address	Item name	Matter
084	Output-ID of the Monitor 1	It sets the ID of the data which is output to the analog monitor 1. Initial value : 45(The ID of the input value from the torque sensor)
085	Output-scale of the Monitor 1	The analog monitor 1 is scaled so that the set value of this parameter becomes 8V output. initial value : 2048
086	Output-ID of the Monitor 2	It sets the ID of the data which is output to the analog monitor 2. Initial value : 41(Current speed ID)
087	Output-scale of the Monitor 2	The analog monitor 1 is scaled so that the set value of this parameter becomes 8V output. initial value : 1500

The output ID set above and its contents are shown below.

ID-Number	Display contents
41 ※(10041)	It represents the current speed [rpm]. It is initialized to analog monitor 2. The initial scale is 1500 [rpm / 8 V].
42 ※(10042)	It represents the motor current value for monitoring [0.01 Arms]. Please set it in torque sensor unused mode.
45 ※(10045)	It represents the output current value of the torque sensor. It is initialized to analog monitor 1. The initial scale is 2048 [Arms / 8 V].

※When using the W type controller and checking CH 2,
please set the value which added 10000 to the number of CH 1.

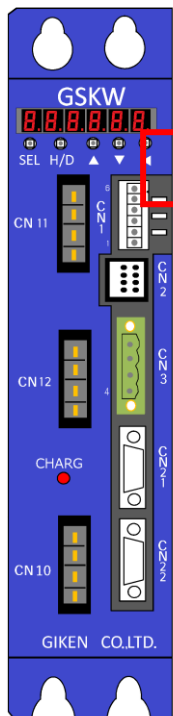

- ※ For GSK-T4-E-N7 and GSKW-T4-E-N7 there is no analog monitor pin notation.
Pins for analog monitor in these controller types are within the red frame in the left figure.
These show the following from the top of the figure.
TP6: M1 pin
TP7: M2 pin
TP 8: GND
When connecting, please connect to pin and GND respectively.

10. Code Table

10-1 NG code list

Operation	Code display	Matter
Basic NG	FFF F00	Emergency stop Preparation for operation off during operation or START OFF in the running program.
Before starting check, etc.	001	Zero offset error During the zero / magnification check, zero point output exceeds the set over range.
	002	Magnification error During the zero / magnification check, magnification output exceeds the set over the range.
	003	Zero offset fluctuation error Difference in the previous and current output value exceeds the limit over.
	004	Magnification fluctuation error Difference in the previous and current output value exceeds the limit over.
	033	1.On Nut runner Tightening sampling error
		2.On Positioning mode Return to origin point over time error
034	Home to return operation at the time of incomplete. Positioning movement command of the X/Y-axis has been issued in the state of that origin return is not yet completed.	
SOC.T	106	Gear checkNG1 In the torque-free monitoring time, angle tightening has reached the cut angle.
	107	Gear checkNG2 Motor current during rotation exceeds the torque upper limit equivalent. ※The torque limit is a current value.
	108	Fitting angle over It does not reach the fitting torque when it exceeds the cut angle.
	133	SOC.T over time The time of this operation has exceeded the set value.
PRE.T	207	Pre tightening early tightening NG It reaches the second speed switching torque between the closed fast decision angle from the start.
	211	Pre tightening torque over The torque value at the time of the end has exceeded the upper limit.
	212	Pre tightening torque under The torque value at the time of stopping does not reach the lower limit.
	221	Pre tightening time over The time exceeds the upper limit when this operation is completed.
	222	Pre tightening time under It does not reach the lower limit when this operation is completed.
	231	Pre tightening angle over The angle exceeds the upper limit when this operation is completed.
	232	Pre tightening angle under It does not reach the lower limit when this operation is completed.
	233	Pre tightening over time The time of this operation has exceeded the set value.
	240	Pre tightening area over The size of the judgment area exceeds the set value.
	241	Pre-tightening seizure torque over If the average torque between angles A and B before the stop torque exceeds the set value, the NG. This function can be used with I/F version: 1899-7.015 or higher and controller version 1851-7.13 or higher.
271	Pre tightening total angle exceeded The angle from the start of Pre tightening to the end of tightening exceeds the total angle upper limit. This function can be used with I/F version: 1899-7.031 or higher and controller version 1851-7.20 or higher.	

Operation	Code display	Matter
	272	Pre tightening total angle under The angle from the start of Pre tightening to the end of tightening does not reach the total angle lower limit. This function can be used with I/F version: 1899-7.031 or higher and controller version 1851-7.20 or higher.
REV.T	306	Reverse tightening pass torque NG During operation, the torque did not reach the set value.
	307	Reverse tightening sticking judgment NG During operation, the torque exceeds the set value.
	311	Reverse tightening torque over The torque at the measurement angle exceeded the judgment torque.
	333	Reverse tightening over time The time of this operation has exceeded the set value.
REA.T	403	Real tightening zone NG Out of the zone determination range at torque method.
	404	Real tightening gradient NG Gradient at an angle method exceeds the set value. It has ended operation before the acquisition of basic gradient.
	407	Real tightening early tightening NG The tightening torque reached the cut torque between the start and the early tightening judgment angle.
	411	Real tightening torque over The torque value at stop has exceeded the upper limit.
	412	Real tightening torque under The torque value at stop does not reach the lower limit.
	421	Real tightening time over The time exceeds the upper limit when this operation is completed.
	422	Real tightening time under It does not reach the lower limit when this operation is completed.
	431	Real tightening angle over The angle exceeds the upper limit when this operation is completed.
	432	Real tightening angle under It does not reach the lower limit when this operation is completed.
	433	Real tightening over time The time of this operation has exceeded the set value.
	434	Real tightening over cut angle Angle from the start was over. (No torque sensor only)
	440	Real tightening area over The size of the judgment area exceeds the set value.
	441	Real tightening snag torque over The snug torque exceeded the upper limit by the angle method.
	442	Real tightening snag torque under The snug torque does not reach the lower limit by the angle method.
	451	Real tightening torque decrease NG The tightening torque becomes lower than the setting value of the real tightening passing torque after passing the snug torque.
	471	Real tightening total angle exceeded The angle from the start of Real tightening to the end of tightening exceeds the total angle upper limit. This function can be used with I/F version: 1899-7.031 or higher and controller version 1851-7.20 or higher.
	472	Real tightening total angle under The angle from the start of Real tightening to the end of tightening does not reach the total angle lower limit. This function can be used with I/F version: 1899-7.031 or higher and controller version 1851-7.20 or higher.

10-2 Alarm Code List

10-2-1 Interface alarm

The table below shows the list of alarms (EC *) that occurred in GSK-IF.

Code display contents	Detection factor	Cause	Measures
EC0 Program No. Error	rogram selection error / Content error	Specified program No. out of range	Confirm program selection signal
		The program data stored by GSK-IF is incorrect (check SUM)	Program reset
		There is no NR axis in multi-axis mode	Confirm unit setting
EC1 Operation content error	Indecipherable operation is set	Program data stored in GSK-IF is incorrect (I found an unknown command)	Program reset
EC2 Motion axis no abnormality ※Reset impossible	Specified axis is not implemented / Axis number is doubled	Unit setting error	Confirm unit setting
		ARCNET communication fails	Connection check between GSK-IF and GSK controller
			Check if the axis number of unit setting and the axis number of GSK controller matching
EC3 FRAM error ※Reset impossible	Error detection by self-check of GSK-IF firmware	Insufficient backup area, etc.	Program reset
EC4 External communication error ※Reset impossible	Communication with the outside (mainly PLC) stopped	M-NET connection miswiring	Wiring check
		Station address on the sequencer side, Transmitted / received byte count error	Sequencer setting confirmation
		M-NET station address setting error	M-NET station address confirmation
		Shield processing failure of M-NET connection line	Wiring check
EC5 Rated number setting error	NR axis, X axis, Y axis Rated number error	NR axis, X axis, Y axis rated designation other than 1 to 30	Program setting confirmation
EC6 Position select error	Position selection error during JOG operation	Position specification for JOG operation is other than 1 to 255	I / O signal confirmation
EC7 CAN communication error	Communication error with Z axis controller (GSK-R3-N1)	CAN cable connection failure	Cable change
		MAC ID of Z-axis controller doubles or disagrees	Review controller settings
		Power off of Z-axis controller	Re-supply operation preparation
EC8 Parameter setting error	Parameters such as unit settings do not conform to setting rules	Unit setting number exceeded (To position unit of maximum unit 4 Against 5 to 7 units) Unit numbers do not match the order of axis numbers	Reset unit settings
EC9 ARCNET communication error at power on	Occurs at power on	ARCNET communication failure	Same as EC2 ARCNET communication error
		No response from controller	Check if the axis number of unit setting and the axis number on GSK controller matching.

10-2-2 Interface alarm details

Interface alarms have multiple causes for each alarm.

The detail code can be found in the configuration software or on the display.

EC0 Selected program error

【Detection content】 Program choice and content issues

【Cause and measures】

Detail code (**1)	Cause	Measures
0101	The selected program number is out of range (0 or exceeded the maximum program number)	Confirm program number of input signal
0201	Some NR axis was moving at program start	Wait for the nutrunner operation to stop before starting
0301	NR axis was moving at block start	Wait for the nutrunner operation to stop before starting
0401	Did not decide which block to execute at the start	Block was not decided at the start
0501	Block to execute was all axes empty	Check the program contents of the number to be executed
0601	The block number you tried to start was over the maximum (IF firmware self-diagnosis error)	Check the version of IF firmware
0701	Zero magnification check turned on in a block where no command exists	Confirm the contents of the program
0801	Use duplicate MARK command of the same number	Confirm MARK command number in program
0901	Retightening start timing is too early	Open about 300ms between retightening signal ON and start signal ON
0A01	Retightening can not start because the number of blocks in each unit does not match	Insert a dummy block and adjust the number of blocks. Or change the mode of retightening
0B01	XY block detected in multiple-axis mode (The unit settings may have been changed but the program has not been overwritten.)	Confirm the contents of the program Write the correct program
0C01	NR block detected in unit in positioning mode and without NR axis	Confirm the contents of the program Write the correct program
0D01	Detecting MOVEXY commands that can not be executed (Ex: Detecting MOVEX command in a unit without X axis)	Confirming the MOVEX, MOVEY, MOVEXY commands Write the correct program
0E01	Detection of non-executable Z-axis commands (Ex: A unit with no Z axis detects a pressing down command)	Confirm Z axis related commands
0F01	Detection of "end synchronization" ON in positioning mode	Program not to use "end synchronization "

EC1 Program step error

【Detection content】 Unreadable operation step in setup program or read error of program step

【Cause and measures】

Detail code (**2)	Cause	Measures
0102	Program backup error (Life of FRAM etc.) (Also occurs when the program is not written once after changing the program Max value setting)	Program rewrite Change IF if it occurs frequently
0202	Detect unreadable step command	Program rewrite ※
0302	Detected SPW command	Program rewrite ※
0402	Program STEP exceeded	Program rewrite ※
0502	Rated number out of range	Program rewrite ※
0602	Insufficient internal memory for program cache (There are valid axis numbers more than the number of axes in program Max value setting)	Confirm unit setting and program Max value setting Program rewrite ※
0702	The program's END command can not be detected	Program rewrite ※

※※If it still occurs, the version of IF may be old. Please check if the IF version is the latest.

EC2 Controller connection error

【Detection content】 Communication error with controller (mainly ARC-NET communication)

【Cause and measures】

Detail code (**3)	Cause	Measures
0103	At startup: Controller version is old	Upgraded controller firmware Change controller
0203	At startup: Controller system number error (Not a GSK controller)	Change controller
0303	At startup: Controller axis not found (No controller response)	Check controller axis number Connection check of GSKIF and controller • Is the termination resistance attached • noise • Poor cable contact
0403	At startup: There is an axis with no control response	
1003	ARCNET communication cut off (Communication was successful at startup, but then failed)	

EC3 Interface unit error

【Detection content】 FRAM (firmware * writing area) abnormality, some abnormality in the Interface unit

【Cause and measures】

Detail code (**4)	Cause	Measures
0104	Parameter backup error (FRAM life etc.) (Possibility that various setting values are broken)	Rewrite GSK configuration parameters Change IF if it occurs frequently
0204	I/O signal definition error (IF firmware self-diagnosis error)	Upgrade of IF firmware version
0304	Insufficient size of program area (IF firmware * problem, insufficient backup area)	Upgrade of IF firmware version

※Here is the operation program of the interface itself

EC4 External communication error (sequencer connection error)

【Detection content】 Communication error with external control equipment (sequencer etc.)

【Cause and measures】

Detail code (***5)	Cause	Measures
0105	Communication failure (at startup)	It depends on the connected device Supplementary materials
0205	M-NET: Receive size specification from the parent station is too small	IO size check on MNET sequencer side
0305	M-NET: Receive size specification from the parent station is too big	IO size check on MNET sequencer side
0405	M-NET: Transmission size specification from the parent station is too small	IO size check on MNET sequencer side
0505	M-NET: Transmission size specification from the parent station is too big	IO size check on MNET sequencer side
1005	Communication failure (successful at startup but later failure)	Supplementary materials

【Supplement】 M-NET

Status	Cause	Measures
Occurs after power on※1	Connection miswiring	Wiring check
	Station address setting error	Check if station address setting matches PLC setting
	Poor shielding of connection lines	Wiring check
※1 In the case of M-NET, EC4 does not occur even if M-NET connection can not be made immediately after GSKIF power is turned on. Occurs when the M-NET connection is made once at power on and then disconnected. If GSIF does not respond to the signal from PLC even though EC4 is not generated, check the above cause / measure.		
Other M-NET indicates the number of transmit and receive bytes from PLC But, it does not check whether this size matches the input / output signal size of GSKIF. Please check the signal size for each PLC station if you can only exchange part of the input / output signals by looking at the IO monitor etc.		
【Related main parameters】 M-NET station address setting: Fn7-No. 03		

【Supplement】 Other than M-NET

Status	Cause	Measures
Occurs after power on※1	PLC connection incorrect wiring	Wiring check
	Mismatch of PLC station address, communication speed, etc. ※ 2	Check if PLC settings and Anybus board settings match
	I / O signal size mismatch	Confirm PLC setting (Fn6-12) Confirm PLC setting 2(Fn6-15)
	Poor shielding of PLC connection wire	Wiring check
Occurs after power on	Poor shielding of PLC connection wire	Wiring check
How to use the Anybus board depends on the PLC type (Devicenet / CCLINK / Profinet etc.). Refer to the instruction manual for each communication standard for details. ※1.The connection sequence with the PLC may take some time to complete, so it may wait up to several tens of seconds for an alarm to be generated. ※2.The setting method differs depending on the PLC.		
【Related key parameters】 PLC setting: Fn6-No. 12		

EC5 Position move failure

【Detection content】 Abnormality regarding positioning operation of XYZ

【Cause and measures】

Detail code (**6)	Cause	Measures
0106	Return: There is an axis that has not been home-returned and can not operate	Home position return
0206	There is an axis for which return-to-origin is not completed, and the program operation can not start	Home position return
0306	Range error of POS number specified in program operation	Confirmation of position number specified by input signal (If there is a Z axis, you can specify up to 160)
0406	There is a problem with the X rating (speed 0, etc.)	Check X rating
0506	There is a problem with the Y rating (speed 0, etc.)	Check Y rating
0606	There is a problem with the Z rating (speed 0, etc.)	Check Z rating
1006	Z axis: Home position return parameter error	Check Z rating
1106	Z axis: JOG parameter error	Check Z rating
1206	Z axis: teaching parameter error	Check Z rating
1306	Z axis descent failed. It tried to descend during Z axis operation	IF firmware rewrite Review the overlap distance of Z-axis rating setting. Insertion of waiting by DELAY command
2206	POS number error on move destination by JOG signal	Check the range of position numbers specified by the input signal
2306	XY movement by JOG signal can not operate	Home position return

EC6 Out of target position range

【Detection content】 Anomaly about move destination of XYZ movement

【Cause and measures】

Detail code (**7)	Cause	Measures
0107	Z axis: Move destination coordinate error, limit over (It tried to move out of the range of rising limit and falling limit)	Confirm Z axis coordinate of specified position
0207	Z axis: Z axis coordinate unknown by cylinder lowering command <ul style="list-style-type: none"> • The coordinate value of Z axis was 0 mm • Return number 255, etc. Point number without Z axis coordinates 	Check if specified point number is within range Check if Z-axis coordinate value of specified point is greater than rising limit
0307	Return destination X coordinate is out of soft limit range	Confirm that the destination XY coordinates are within the soft limit Expand the soft limit range as needed
0407	Return destination Y coordinate is out of soft limit range	
1007	X coordinate of program destination is out of soft limit range	
1107	Y coordinate of program destination is out of soft limit range	
2007	X coordinate of JOG signal destination is out of soft limit range	
2107	Y coordinate of JOG signal destination is out of soft limit range	

EC7 CAN communication error

【Detection content】 CAN communication error

【Cause and measures】

Detail code (***8)	Cause	Measures
0108	CAN open failure (insufficient resources such as RAM)	Upgrade of IF firmware version
0208	CAN communication failure at startup <ul style="list-style-type: none">• Connection failure of CAN cable• Z-axis axis number doubles, disagreement• Power off of Z axis driver etc	Wiring confirmation (termination resistance etc.) energization check Axis number (MAC-ID) confirmation
0308	CAN communication failure after startup (Communication has been broken since connecting once)	Wiring check

EC8 Parameter setting error

【Detection content】 The content of the parameter set in the interface does not conform to the setting rule

【Cause and measures】

Detail code (***9)	Cause	Measures
0109	UNIT setting: There is no valid axis	Unit setting check
0209	UNIT setting: UNIT number per axis is not in ascending order	Unit setting confirmation Unit number in ascending order Determine the axis number
0309	UNIT setting: Axis number is not in the order of NR / X / Y / Z	Unit setting check. Assign the nut runner axis, X axis, Y axis, Z axis in ascending order of axis number for the axis of the same unit
0609	UNIT setting: UNIT number over (The upper limit of positioning is 4 units)	Fit within 4 units

EC9 Tightening operation abnormality

【Detection content】 Abnormality in operation of nutrunner

【Cause and measures】

Detail code (***A)	Cause	Measures
010A	Axes other than NR axis are off (setting software)	Check the contents of the off axis setting
020A	Axes other than NR axis are off (input signal)	Check input signal for axis turning
200A	NR axis movement: Start failure (The selected program number or program content is broken)	Confirm selected program number Check the contents of the inching program In some cases, rewriting is necessary
210A	NR axis movement: Start failure (There was no program that was valid for one axis in the selected program)	Check the contents of the inching program (At least one axis must have a tightening block)

10-2-3 Alarm generated in the GSK driver (E**)

Code	Alarm names and detection contents / Cause of generation and treatment
E11	[IPM error] Power drive signal error (overcurrent / overheat / power supply error) 1. Short circuit between motor windings : Replace motor 2. Short circuit of motor connection cable : Replace cable 3. Controller drive circuit failure : Replace controller 4. Overheating due to overload 5. The ambient temperature of the controller is abnormally high : Review the installation environment 6. Fan does not work : Replace controller
E21	[Overload] The motor average current exceeded the "overload alarm detection value" (see * 6-1) 1. Excessive load torque : Reduced load 2. Acceleration / deceleration frequency of operation is too high : Change of operation pattern 3. Overload alarm set value is too small : "d00104" parameter change 4. Sensor setting error : Review parameters of "d00141"
E22	[Current control error] The average deviation of the current control loop exceeded the "current control error value" 1. Motor disconnection : Replace motor 2. Broken motor connection cable : Replace cable 3. Occurrence of abnormal vibration : Readjustment of servo gain 4. Resolver NR is used : "d00114" parameter review
E31	[Overspeed] The motor speed exceeded the "overspeed alarm detection value". 1. Excessive command speed : Review of command speed 2. Overspeed detection set value is too small : "d00105" parameter change * * There is a difference in initial value between NR and positioning. Representative value NR : 15000 Positioning : 7500 Since the value varies depending on the model, please contact the manufacturer for details. 3. Overshoot during control : Servo gain readjustment 4. After resetting the absolute position detection sensor : Reset the alarm again.
E41	[Position control counter overflow] Position data exceeds $\pm 68000000h$ 1. Rotated in a certain direction for a long time: Review of operation pattern 2. Does not move due to cable disconnection or wiring mistake: Cable replacement
E42	[Excessive deviation] Position deviation exceeded "deviation error detection value" 1. A large position command has been added in steps: Review of the position command 2. Motor disconnection: Motor replacement 3. Disconnection of motor connection cable: Encoder / resolver cable replacement 4. Abnormal vibration occurs: Servo gain readjustment 5. Setting error of angle sensor resolution: "d00141" parameter review
E61	[Sensor error] Encoder signal cannot be detected (disconnected) 1. Broken motor angle sensor connection cable : Replace the cable 2. Sensor setting error : Review parameters of "d00140" 3. Abnormal sensor attached to motor : Replace motor
E62	[Sensor abnormality] Abnormal sensor signal from resolver backup unit 1. After an error occurred, the power was turned off without resetting : Reset the R / D_board. 2. Resolver backup unit error : R / D_board replacement 3. Motor sensor magnetic pole signal error : Replace motor
E63	[Sensor error] Communication error with SmartInc or SmartABS encoder / resolver 1. Connection cable error: Replace cable 2. Resolver backup unit error: R / D_board replacement 3. Abnormal motor angle sensor: Replace motor
E64	[Sensor error] SmartInc or SmartABS encoder detected an error 1. Overflow count value overflow : Reset of multi-turn position data by alarm reset 2. Battery voltage drop : Replace battery after error reset 3. Cable breakage between resolver backup unit and resolver : cable replacement 4. Abnormal motor angle sensor : Replace motor 5. Malfunction of backup unit due to noise : Review cable connection and ground connection, and install ferrite core on motor connection line 6. Uncertain origin : Return to origin

E65	[Sensor abnormality] There is no HZ state when the power saving encoder power is ON 1. Sensor setting error : Review parameters of “d00140” 2. Abnormal motor angle sensor: Replace motor
E66	[Abnormal sensor] Excessive amplitude of resolver signal 1. Unresolvable resolver : Please contact us 2. Sensor setting error : Review parameters of “d00114” and “d00142” 3. Resolver reception circuit error : Replace controller 4. A value exceeding the motor speed upper limit was set : Review of settings 5. Disconnection between resolver backup unit and resolver : cable replacement
E67	[Sensor abnormality] Sensor signal abnormality Multi-turn overflow of resolver backup unit
E69	[Sensor abnormality] Sensor signal abnormality 1. Resolver backup unit error
E71	[Overvoltage] Excessive drive power supply voltage 1. Drive power supply voltage exceeded 800V: Review of drive power supply 2. Drive voltage detection circuit malfunction: Controller replacement
E72	[Voltage drop] Drive power supply voltage drop 1. The drive power was turned off while the servo was on: Controller replacement
E73	[Regeneration abnormality] Voltage does not decrease due to regeneration 1. Regenerative resistance is too large : Replace the controller because the regenerative resistance cannot be replaced.
E74	[Regenerative abnormality] Regenerative resistance overload 1. Insufficient capacity of regenerative resistor : Since the regenerative resistor cannot be replaced, replace the controller.
E81	[Abnormal control power] Decrease of control 24V voltage 1. Control 24V voltage dropped : Review of external power supply unit 2. Abnormal voltage detection circuit : Replace controller
E82	[Bus failure] Cannot read / write data between CPU and peripheral device normally 1. CPU peripheral circuit error : Controller replacement
E83	[Current offset error] The offset value of the current sensing circuit is abnormally large 1. Abnormal current detection circuit : If the alarm cannot be reset after turning the drive power off, replace the controller.
E91	[Non-volatile memory error] Data cannot be read normally 1. Non-volatile memory malfunction or memory data destroyed : Resetting parameters Display d00000 or d10000 on the 7 segment screen of the controller where the alarm is occurring. ▶Press and hold to save parameters. Turn the power off and on. : Parameter initialization and resetting or controller replacement
E92	[Non-volatile memory error] Data cannot be written normally (E92) Data cannot be erased normally (E93) Write check failure (E94) 1. Malfunction of nonvolatile memory : If the parameter is saved again and the alarm cannot be reset, replace the controller.
E95	[Non-volatile memory error] Abnormality of the data to be written 1. There is a parameter setting value exceeds the allowable range : Review of the parameters
EA0	[Nutrunner operation parameter error] 1. Abnormal parameter sent from IF to controller : Review of setting values
EA1 EA2 EA3	[ARC-Net initialization failure] 1. ARC-Net IC error : Controller replacement
EA4 EA5	[ARC-Net communication error] 1. Communication is not possible due to noise, etc. : Cable inspection, terminal processing inspection, shield processing inspection

Eb1	[Home position return error] Can not detect home sensor
Ed0	[Z-axis pressing error] CH2 side is not Z axis
Ed1	[Z-axis pressing error] CH1 side is not nutrunner axis
Ed2	[Z-axis pressing error] CH1 and CH2 are not the same unit number

11. Indication of display

【Axis array】

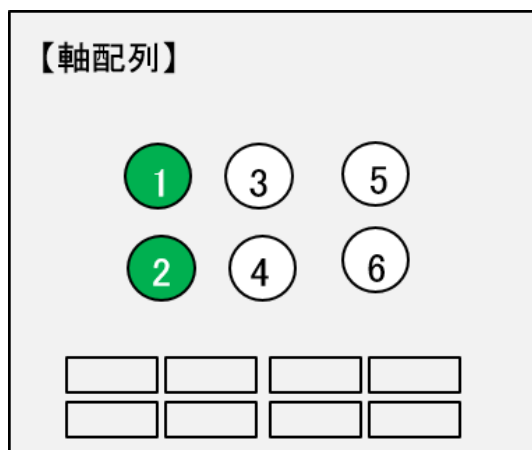

This screen shows the alignment of the axes. Each screw is displayed in white before tightening, in green when tightening is OK, and in red when tightening is not performed. If the screw display number is set to a value over 60, the axis number is not displayed.

【Tightening data】

【締付結果データ】 ▲ ▼ 戻る

	トルク	時間	角度	判定
No.01	0.5	15014	0.1	233:仮締付
No.02				
No.03				
No.04				
No.05				

This screen displays the tightening result data. A message of NG code or alarm result is displayed in the judgment column.

【Tightening wave】

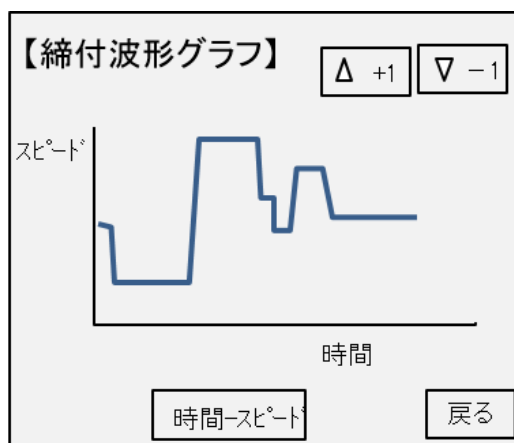
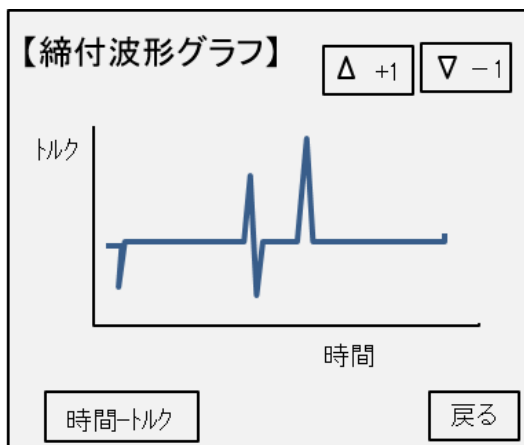

There are the following types of tightening waveforms that can be viewed on this screen.

- "Horizontal axis: time-vertical axis: torque"
- "Horizontal axis: time-vertical axis: speed"
- "Horizontal axis: angle-vertical axis: torque"
- "Horizontal axis: angle-vertical axis: speed"

【Setting Menu】

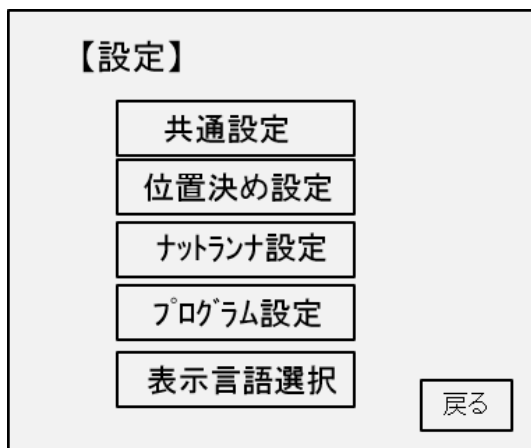

You can check various setting parameters in the items on this screen.

In the nutrunner setting, you can change the setting by entering a password.

【Display language】

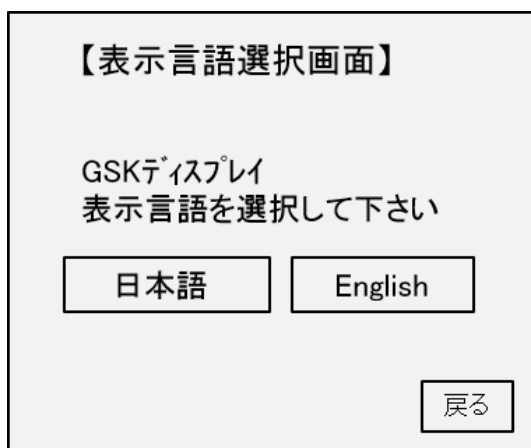

It's possible to change the language shown to a display.

The language which can be indicated is two, Japanese and English.

【Common settings】

【共通設定】

バージョン情報
ドライバ :
インターフェース :

ユニット設定

締付データ出力設定

オプション設定

戻る

There are [Unit setting] [tightening data output] [option setting] in the common setting menu.

【Unit setting】

【ユニット設定】

軸No.	ユニットNo.	種類
No.01	1	N
No.02	1	X
No.03	1	Y
No.04	0	
No.05	0	
No.06	0	

戻る

This screen displays the motor type of each axis and the unit number to which it belongs.

【ID-Controller settings】

【締付データ出力-1】

各種判定送信有無選択

ネジNo.送信有無選択

エンジンNo.桁数選択

出力タイミング設定

▼

In this screen it sets the tightening data output from the controller.

【Option settings】

【オプション設定】

M-Netアドレス設定

PC通信速度設定

M-net I/Oモータユニット選択

This screen displays the settings in the option items.

【Positioning settings】

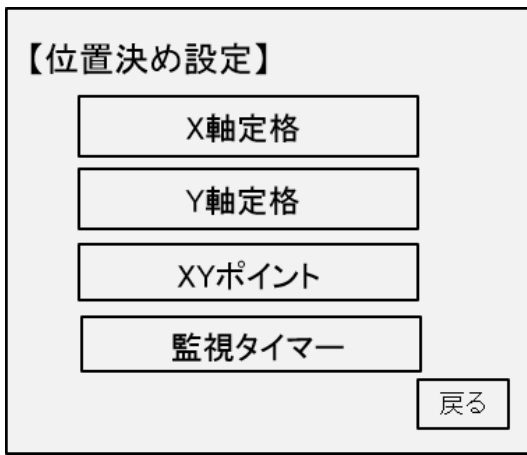

This item sets the ratings and coordinates required when using positioning control with the X-axis and Y-axis.

【X axis rate settings】

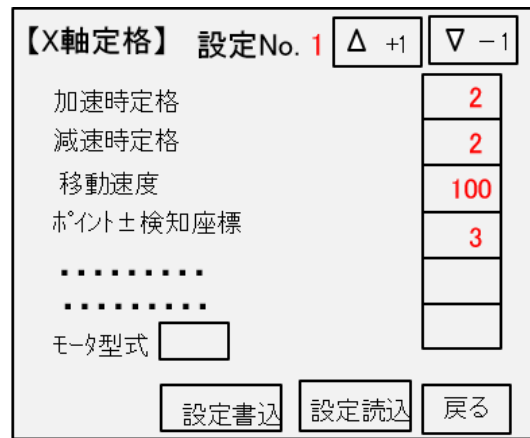

This screen sets each parameter details of X axis motor rated value setting. There is a screen to set the rated value of Y-axis motor with the same setting contents.

【XY point】



This screen displays the details of each parameter of coordinate position.

【Interference region settings】

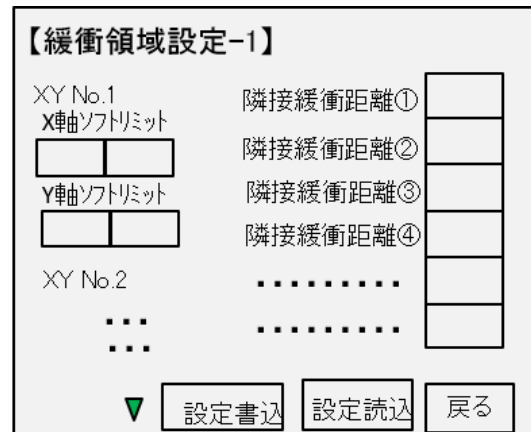

This screen displays parameters related to the movement range of the XY axis.

【Supervisory】

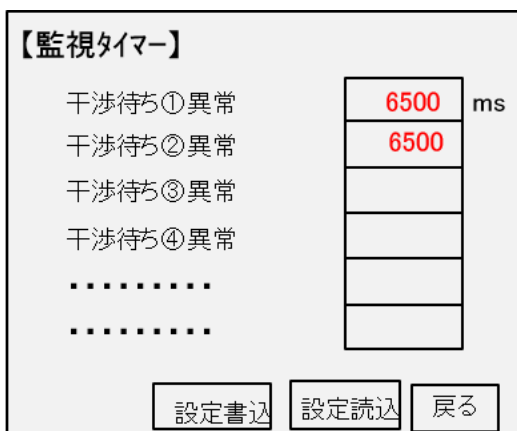

This screen shows the details of each time limit.

【Nut runner setting】

【ナットランナ設定】

定格設定	逆転
ソケット合わせ	本締
仮締	データ収集設定

戻る

There are [Rate setting] [SOC.T] [REV.T] [PRE.T] [REA.T] [Data collection] as nut runner setting.

【Rate setting】

【定格設定】 設定No. 1 Δ +1 ▽ -1

ナットランタイプ	トルクセンサ定格	
センサタイプ	リミットオーバ	
モータ型式	セットオーバ	
ネジ締め方向	零点フリセット値	
	ゲイン補正值	
	減速比	

設定書込 設定読込 戻る

This screen displays each parameter of the nutrunner used on the rated setting.

【SOC.T】

【ソケット合せ】 設定No. 1 Δ +1 ▽ -1

回転速度	
スピード	
回転方向	
<オプション>	
動作	
検出トルク	
オーバータイム	
前時間	

設定書込 設定読込 戻る

The parameter of SOC.T set value is displayed. Finer control and judgment can be performed with the setting items of the option.

【PRE.T】

【仮締-1】 設定No. 1 Δ +1 ▽ -1

<ねじ合わせ>	
回転速度	
スピード	
<早送り>	
早送り角度	
スピード	
早締め判定トルク	

▼ 設定書込 設定読込 戻る

【仮締-2】 設定No. 1 Δ +1 ▽ -1

<着座>	
仮締めトルク	
トルク上限	
トルク下限	
スピード①終了トルク	
.....	
.....	
.....	

▲ ▼ 設定書込 設定読込 戻る

The parameter of PRE.T set value is displayed. Finer control and judgment can be performed with the setting items of the option.

【REV.T】

【逆転-1】 設定No. 1 Δ +1 ▽ -1

<着座>

判定トルク	
逆転角度	
スピード1	
計測角度	
通過トルク	
焼付トルク	
オーバータイム	

▼ 設定書込 設定読込 戻る

This screen displays the set value parameters in reverse operation.

【REA.T-torque method】

【本締-1】 設定No. 1 Δ +1 ▽ -1

締付モード

トルク法

本締トルク	
計測開始トルク	
スピード1	
スピード1終了角度	
スピード2	
.....	
.....	

▼ 設定書込 設定読込 戻る

【本締-2】 設定No. 1 Δ +1 ▽ -1

締付モード <オプション>

トルク法

前時間	
時間上限	
時間下限	
角度上限	
早締め判定角度	
.....	
.....	

▲ ▼ 設定書込 設定読込 戻る

The parameter of REA.T set value in torque method control is displayed. Finer control and judgment can be performed with the setting items of the option.

【REA.T-Angle method】

【本締-1】 設定No. 1 Δ +1 ▽ -1

締付モード

角度法

スナグトルク	
停止トルク	
締付角度	
オーバータイム	
トルク上限	
.....	
.....	

▼ 設定書込 設定読込 戻る

【本締-2】 設定No. 1 Δ +1 ▽ -1

締付モード <オプション>

角度法

早締め判定角度	
トルク無監視時間	
判定面積	
実施 勾配判定	
勾配サンプリング数	
.....	
.....	

▲ ▼ 設定書込 設定読込 戻る

The parameter of REA.T set value in angle method control is displayed. Finer control and judgment can be performed with the setting items of the option.

【Password input】

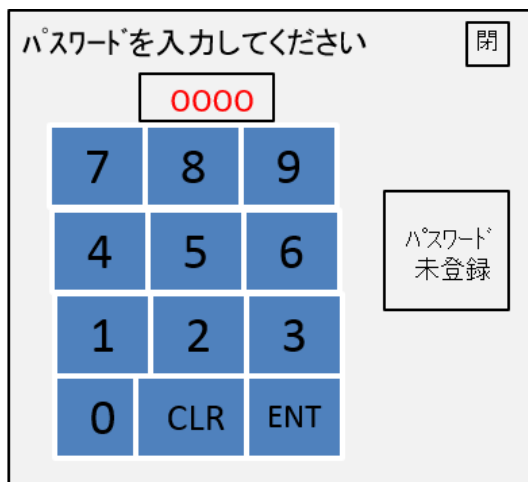

The password entry screen shown on the left will be displayed by pressing the “[Write settings]” button on each setting screen.

Each parameter in the nut runner setting can be changed by entering the password and the ENT key.

【Data collection】

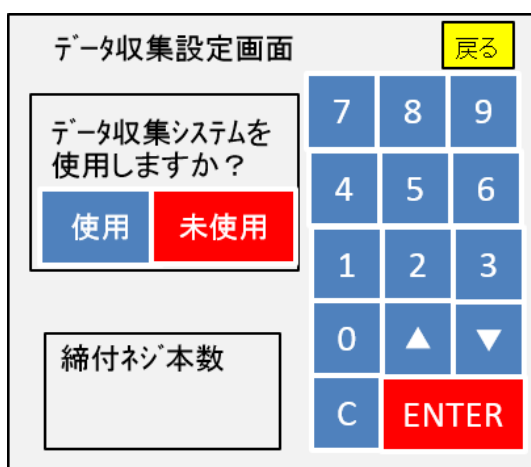

When USB is inserted in a display when "use" is chosen from a data collection setting, a tightening result is preserved by a USB memory by a CSV format.

【Program setting】

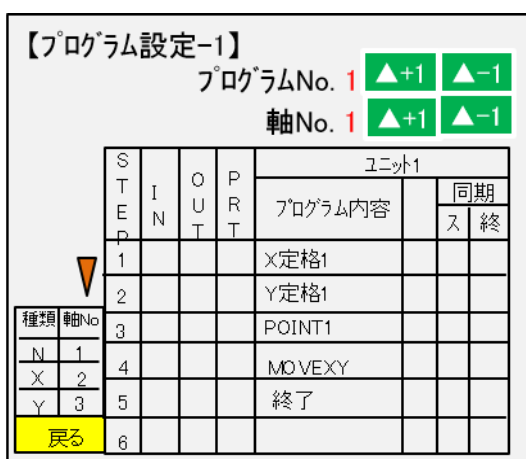

The program setting can be confirmed.

【I/O monitor input】

【IOモニタ入力-1】			
PLC ⇒ GSK			
運転準備	<input checked="" type="checkbox"/> プログラムビット1	XJOG+	
自動/各個	<input checked="" type="checkbox"/> プログラムビット2	<input checked="" type="checkbox"/> XJOG-	
スタート	<input checked="" type="checkbox"/> プログラムビット3	YJOG+	
寸動スタート	プログラムビット4	XJOG-	
判定リセット	プログラムビット5	INX①	
アラームリセット	プログラムビット6	INX②	
QL信号入力	入力ENABLE	INY①	
QLモード	GSKリセット	INY②	

ユニットNo. 1

It's possible to do input confirmation of I/O monitor.

A screen is changed by an arrow button.

【I/O monitor output】

【IOモニタ出力-1】			
GSK ⇒ PLC			
運転準備完了	<input checked="" type="checkbox"/> プログラムビット1	締付総合OK	
NR装置正常	<input checked="" type="checkbox"/> プログラムビット2	<input checked="" type="checkbox"/> 締付総合NG	
バッテリー正常	<input checked="" type="checkbox"/> プログラムビット3	X原点復帰	
総合OK	プログラムビット4	Y原点復帰	
総合NG	プログラムビット5	零/倍OK	<input checked="" type="checkbox"/>
NR運転中	プログラムビット6	零/倍NG	
QL処置完了	出力ENABLE	<input checked="" type="checkbox"/> サイクルストップ	
プログラム実行中	<input checked="" type="checkbox"/>	OUT	

ユニットNo. 1

【IOモニタ出力-4】			
GSK ⇒ PLC			
17軸OK	25軸OK	33軸OK	
18軸OK	26軸OK	34軸OK	
19軸OK	27軸OK	35軸OK	
20軸OK	28軸OK	36軸OK	
21軸OK	29軸OK	37軸OK	
22軸OK	30軸OK	38軸OK	
23軸OK	31軸OK	39軸OK	
24軸OK	32軸OK	40軸OK	

ユニットNo. 1

It's possible to do output confirmation of I/O monitor.

A screen is changed by an arrow button.

12. Maintenance and inspection

12-1 Notes

12-1-1 Maintenance and Inspection Precautions

- After powering off and power detection, you should remove the unit.
- Do not work with wet hands. It may cause an electric shock.
- Do not measure the insulation resistance of the controller. It may cause damage to the controller.
- Do not disassemble or repair by yourself.

General usage

Operation at an average of 20 hours or less at an ambient temperature, an average of 30 ° C per year, and a load factor of 80% or less.

12-1-2 Inspection items

Daily check

- Check for unusual vibration or sound.
- Check for abnormal odor.
- Check the wire for flaw and cracks. Special care should be taken to inspect the movable cables.
- Check the driver ventilation hole for foreign matters attached.

Regular inspection (1 year)

- Check the screws at tightening point for loosened condition.
- Check the tightening section for alignment failure.
- Check the cooling fan for any damage.

12-1-3 lifespan

The service life of each part varies depending on the environmental conditions and usage.

You need to replace it after confirming the abnormality.

Product	Parts	Standard replacement interval	Remarks
Controller	Capacitor	About 5 years	Standard exchange time is reference time. Even if the standard replacement time is not reached, it should be replaced when an abnormality is found.
	Relay	about 100,000 operations	
	Cooling fan	10,000 to 30,000 hours	
	Battery	About 2 years	
	E2PROM	10,000 times of overwriting operation	

12-1-4 Capacitor

The characteristics of the smoothing capacitor etc. deteriorate due to the ripple current.

The life of the capacitor depends on the ambient temperature and operating conditions.

In a typical use situation, it will be about 5 years in life.

12-1-5 Relay

This part causes contact wear due to the switching current.

The life of this part is about 100,000 operations.

12-1-6 Cooling fan

Depending on the bearing life of the cooling fan, it will be the life in continuous 10,000 to 30,000 hours.

12-1-7 Battery

Battery life is basically about 2 years. But it varies depending on the application to use.

12-1-8 E2PROM

E2PROM for parameters storing has the limit of overwriting frequency.

Data holding time is about 10 years.

12-2 Warranty

The overwriting frequency under the guaranteed condition is as follows as an outline.

It is restricted by the shortest condition in the following terms.

Parameter overwrite (Fn01 to Fn12)	Each 10,000 times/total
Program overwrite	10,000 times/each axis
Tightening history data	Tightening of about 10,000,000 times/axis
Engine number data	About 59,520,000 units
Alarm history	Alarm 10,000 vtimes occurrence/each axis

12-3 Tightening operation glossary

UNIT:

Multiple axes control up to 30 axes can be treated as each axis to independently operate or as a group of several axes (a unit) to operate together. One interface unit can control the maximum 7 units.

At least one controller belongs to one unit (maximum 30 axes control to one unit), and one input command is assigned to one unit and then all belonging axes start operation simultaneously.

In SIO, different station numbers assigned to each unit.

PROGRAM:

The screw tightening program can save up to 50 programs.

One program can set up to 220 steps of operation starting from control flag (with or without zero check etc.) and rated setting.

However, the rating, screw number and end are also treated as one step.

The program must have at least one block set.

BLOCK:

A block is a group of operation commands in a screw tightening program.

The block shows the grouping of steps starting from the start declaration to the end declaration.

In automatic operation, one block is executed with one start signal input.

At the block end declaration step, GSK outputs the judgment (block OK / NG) on the operated block.

If it becomes "NG" at any step in the block, it will be judged as "block NG" (except when there is a retry) and the next step will not be executed.

After judgment output, the program start starts from the next block.

STEP:

Each operation (Rotation, pretightening, reverse rotation and final tightening), block start declaration, screw number, block end declaration, and retry are called steps respectively.

Step 1 will be always the block start declaration and the step 2 will be always the screw number because more than one program is needed in a program.

Program is executed from the step 1 and finished by the end declaration at the final block.

On the step of the final block end declaration, the total determination (Total OK/NG) is output.

Each axis in the unit operates by step synchronization and the axis in which step has been complete turns OFF the servo motor and waits for the step completion of other axes.

When steps of all axes are complete, the next step will be operated.

QL PROCEDURE:

If a block with Real tightening operation does not complete screw tightening operation under the specified conditions, the block will output "NG" judgment.

The operator needs to manually retighten the screws when finding this "NG" judgment.

At this time, you can change the judgment "NG" to "OK" by inputting the tightening output of the manual torque wrench.

This input is called a QL procedure.

RETRY:

If NG in each operation (SOC.T, PRE.T, REV.T and REA.T) in the block, it is possible to retry the operation.

If NG occurs from the block start declaration to the step before the retry,

the operation from the retry to the end is executed.

If NG did not occur, the operation following the retry will not be executed.

END SYNCHRONIZATION:

At the end of the PRE.T or REA.T operation step, torque confirmation is performed again for only the OK axis.

In this synchronous operation, torque check is performed at 5 rpm until the cut torque, cut angle or overtime is reached.

This synchronization has no effect if it is set to SOC.T and REV.T.

(If this tightening operation is the angle method, never set this synchronization.)

SOC.T:

Used for screw pick up (a socket picks up a screw head) operation before tightening or preventive operation against socket-engagement after tightening.

PRE.T:

This is an operation that performs temporary tightening until the screw is seated.

REV.T:

Operation to unfasten the seated screw by several turns in order to transit to REA.T.

(Inspection of screw burn-in caused by temporary tightening)

REA.T:

This action is used for final tightening of the screw.

ZERO MAGNIFICATION CHECK:

This is an operation that automatically checks and adjusts the torque sensor's zero point and magnification before the tightening block starts.

※If zero times check is set in the program, the torque sensor zero point is automatically set to 0.

However, if it is more than the set-over value of the rated setting, zero times NG will occur.

APPLICABLE TO QC PERSONAL COMPUTER:

Automatic gain of the tightening data and tightening waveform (Simultaneous use with a printer is not possible.)

※Tightening data : "Machine No.", "Axis No.", "Screw No.", "Date", "Time", "Program No.", Pretightening torque, Pretightening angle, Reverse time, Reverse angle, Final tightening torque, Final tightening time, Final tightening angle, Final tightening snag torque, Gradient, Rotation torque judgement, Unit No., Engine No.

※Tightening waveform : Waveform from the final tightening snag torque to the finish,

ID CONTROLLER COMPATIBLE:

The interface unit and ID controller can be connected via serial I / O, and engine number, calendar settings, and result data can be sent.

(This cannot be used simultaneously with the printer.)

APPLICABLE TO PRINTERS:

The angle from the start to the stop is taken into the computer. This is not a programmatic action.

(Executable only from a PC or SIO)

TIGHTENING ANGLE SAMPLING OPERATION:

This is an operation that rotates in the tightening direction at a constant speed to measure the screw length and ends when it reaches the set torque.

The angle from the start to the stop is taken into the computer. This is not a programmatic action.

(Executable only from a PC or SIO)

END, STOP:

During tightening operation (SOC.T, PRE.T, REV.T and REA.T),

the operation may be finished to stop when the condition is matched.

This point that the condition matches (during the motor running) is defined as "End" and the point actually the motor stopped is defined as "Stop".

Most NG determination is executed after "Stop" is established.

13. Supplemental explanation

13-1 Precautions for wiring the Arc-Net

Please use the following drawing for the Arc-Net wiring.

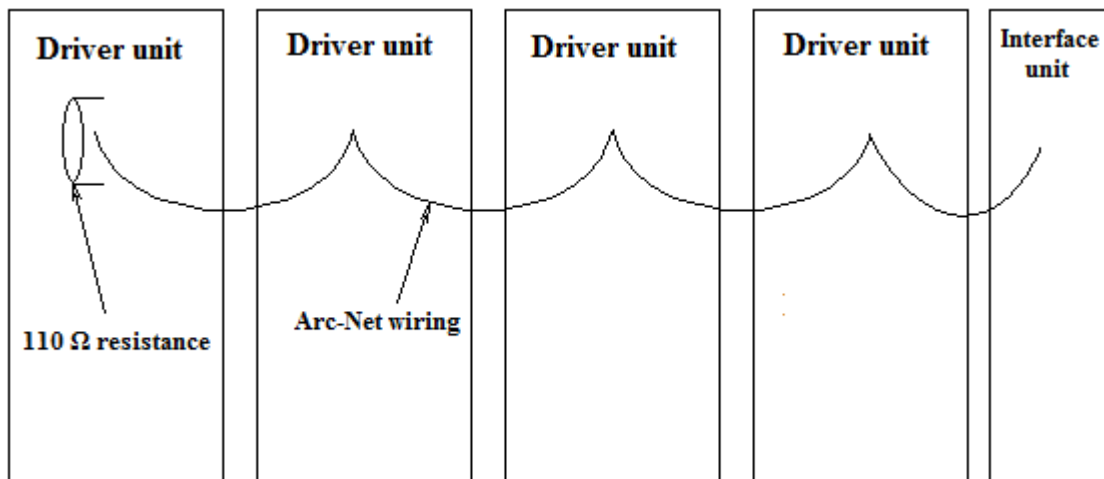

Please set 110Ω resistor to (+)(-) on the arc net connector of the end unit driver .

Notes on using M-net communication

When selecting M-net for communication with PLC, you must set the M-net start address setting "Fn. 7 No. 03" from the 7SEG panel.

(If PLC SIO address does not match GSK's M-net start address setting, PLC can not communicate with GSK)

The password of GSK setting software

The initial password for writing settings with the configuration software is "2014".

This can be changed in the setting software configuration file.

13-2 About GSK additional functions

13-2-1 Area judgment

You set the area value to be used for judging screw defects.

Calculation of area value is obtained by integral calculation on torque and angle curve during Pre-tightening cycle.

With the tightening waveform of the automatic measurement item in the setting software, you can check the waveform used for this calculation.

To see this waveform, you select "Extended waveform".

13-2-2 Smooth tightening

This tightening controls the rotational speed steplessly.

You can set this tightening method by the option of the final tightening cycle.

By setting initial speed and the speed at the cutting torque, the rotation speed changes steplessly according to the change of torque.

13-2-3 S-shaped control

It adjusts the acceleration / deceleration of the motor from the distance to the destination point when controlling the positioning motor.

And it controls so that the nut runner axis curves smoothly.

13-2-4 Z axis pressing control

It is possible to press the screw to be tightened against the seating surface to a set height with a constant force by using the torque control function of the Z-axis driver with a positioning motor.

In this way, the mechanism of the socket's cushion spring can be substituted by control.

13-3 Function to connect with EtherNet (FTP transfer)

This enables EtherNet (LAN) connection by attaching an EtherNet / IP board to the GS-KIF CN14 connector.

This will enable you to save the tightening results as a file on an FTP server.

※This function can not be used with system GSK. .

13-4 SD card

In GSK, several functions can be used by inserting the SD card memory into the SD card slot at the top of the I / F. The available functions are shown below.

- (1) Automatic storage of tightening result
- (2) Analysis of fastening data using analysis software

※Caution※

The SD card that GSK supports is up to "SDHC". Please note that it does not correspond to "SDXC" type.

The following table shows the lighting state of the LED and the state of the SD card at that time.

	State	Explanation
LED2	Light OFF	No SD card inserted
	Lit green	SD card inserted (idling)
	Blinking green	SD card inserted (accessing)
	Lit red	SD card inserted in write-protected state
	Blinking red	SD card access error occurred or waiting for removal and insertion of SD card after saving (GSK-IF ⇒ SD)

13-4-1 AUTOMATIC STORAGE OF TIGHTENING RESULT

The tightening result when operating automatically, is received at any time from GSK interface and the data is preserved in a "HISTORY.CSV" file.

• SAVE.INI file

When this automatic preservation is performed with multi-axis tightening, it may take too much time to store all the waveform data.

In that case, setting "SAVE.INI" file in the SD card makes it possible to shorten the writing time by reducing the amount of data to be written to the "HISTORY.CSV" file.

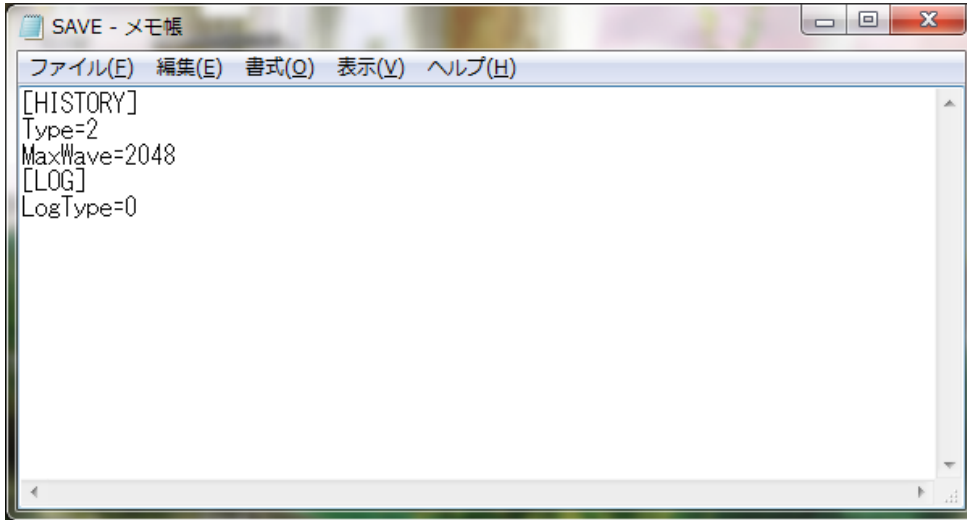

The following table shows the setting in this configuration file.

Items		Explanation	Setting contents
[HISTORY]	Type	It sets the saving pattern of the tightening history. Please select the setting contents from the right column.	0: Don't save 1: Save only the tightening result 2: Save tightening result + save waveform 3: Save the tightening result + save waveform when NG
	MaxWave	It sets the number of sampling in one waveform. It takes 0.01 seconds per sampling. Therefore, the maximum time of the waveform to be saved with this setting is determined. Waveforms exceeding this setting are not saved.	Please specify a value in the range from 1 to 2048. ※The smaller the value, that is the shorter the write time.
[LOG]	LogType	It sets whether to write the operation record of the program.	0: Don't write 1: Write

If the "SAVE.INI" file does not exist in the SD card, it will be saved with the following settings.

TYPE = 2

MaxWave = 2048

LogType = 0

• HISTORY.CSV

When the SD card is inserted into the slot of the GSK-IF, the tightening result is written to the SD card.

"HISTORY.CSV" is the file which the tightening result is written at this time.

The file name actually saved is "0000_his.CSV".

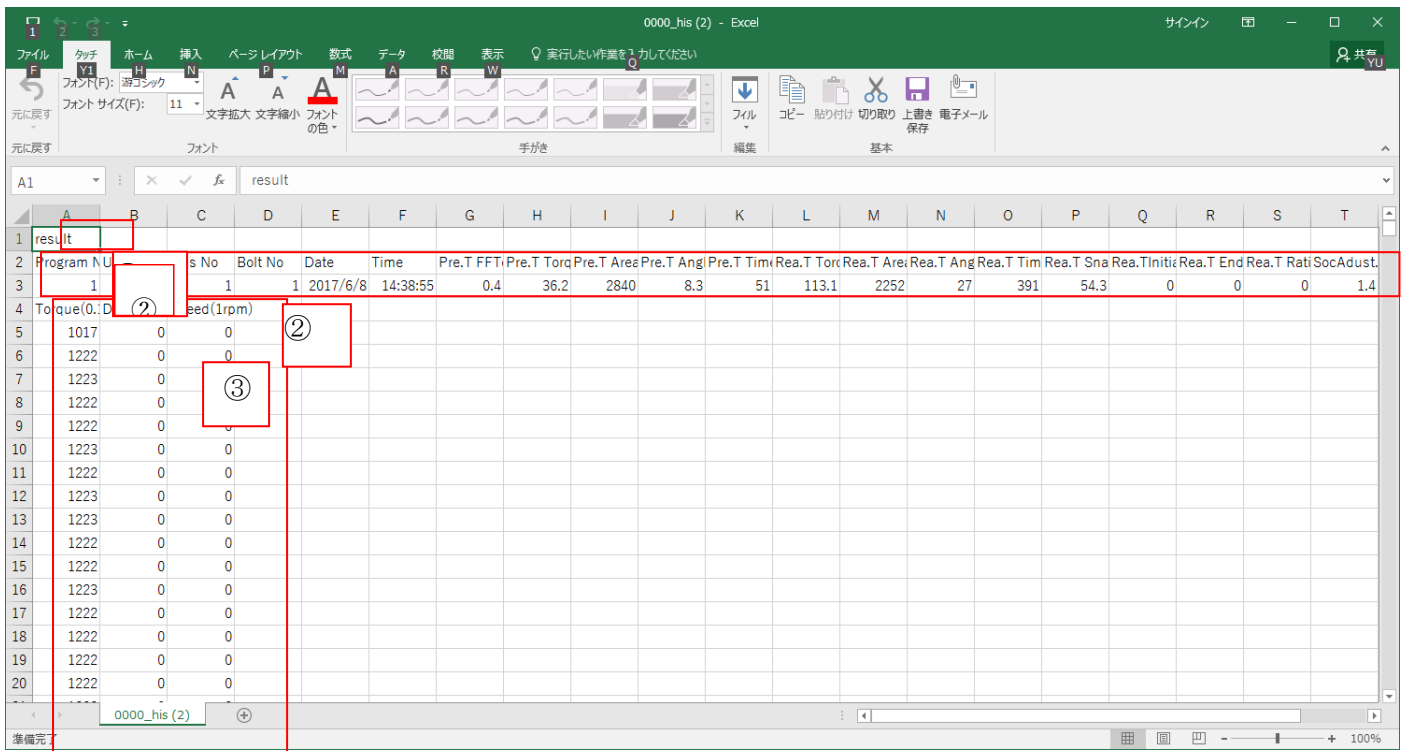

Below is a description of the number in the above figure.

- ①: This is the title of the history. "Result" is fixed.
The data etc. read by the support system are not shown in this notation, please use it to distinguish.
- ②: The details of the tightening result are shown.
The result data is saved in the same format as "Online" of the setting software.
- ③: Sampling data which used for waveform image creation is recorded.
It records torque, angle, rotation speed every 10 msec.

About 1000 items can be saved in this file (※).
If it is over, it names the current history file by date and time and it saves the result to a new history file.
Please refer to the table below for name change.

Order	Contents	String
1 st and 2 nd Character	Renamed date	01~31
3 rd and 4 th Character	Renamed hours	00~23
5 th and 6 th Character	Renamed minutes	00~59
7 th Character	Renamed second (10 of digits)	0~5
8 th Character	Renamed month	1~9,A(October),B(1November),C(December)

(Example: When splitting at 23:50:35 on October 3 ⇒ "0323503 A. CVS")

If a file with the same name already exists, it delete the existing file and it rename the current file.

13-5 Predictive maintenance function

※This function can be used with I/F version 1899-7.018 or higher.

This function is available with GSK setting software version 7.0.24 or higher.

13-5-1 Outline of Predictive Maintenance

The predictive maintenance function is a function to urge early exchange and maintenance by notifying before the GSK Nutrunner system fails.

This function prevents occurrence of breakdown on the manufacturing line.

Controller electronic component life warning	This function warns the parts life of the GSK system (GSKIF / GSK driver). Warning will be issued when parts life comes close, such as electrolytic capacitors and relays. Warnings can not be reset without replacement work.
Nutrunner failure prediction warning	This function is a warning that occurs according to the state of the nut runner, such as overload. Warnings are cleared by turning off the power or resetting.

13-5-2 Flow to alarm notification

The GSK system possesses a predictive maintenance function for warning of electrical parts life warning and protection warning.

The following shows the flow until a warning is notified.

1. Each driver notifies the current state to the GSK I / F
2. When the GSK I/F judges that a warning has occurred, it turns on the protection warning or Lifetime warning bit of the IO output signal.

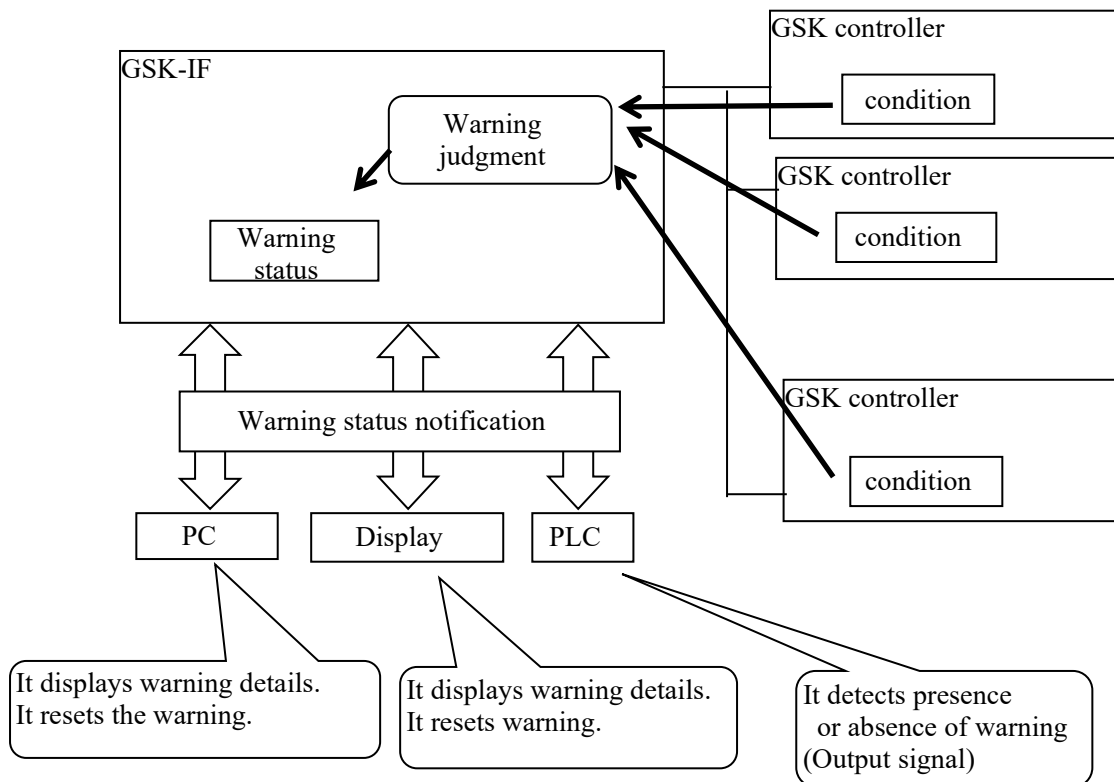

13-5-3 GSK controller Electronic component lifetime warning

If even one of the following warning conditions occurs, the output signal to the PLC "warning of electrical component life warning" turns ON.
 The warning level in the table is the initial value and so it is possible to change from 7 segment monitor.
 If warning level is set to 0, warning judgment is not performed.

Driver's electrolytic capacitor lifetime warning

Warning content	Lifetime warning of electrolytic capacitor mounted on GSK drive
Warning level	4 years (lifespan: 5 years)
Determination method	We write the date of manufacture when manufacturing the GSK driver. The GSK I / F compares the manufacture date of each driver with the current date and It judges whether it exceeds the warning level or not. ※However, if the date of manufacture is all 0, it will not be checked.
Warning Reset	That is impossible.

Driver's relay lifetime warning

Warning content	Lifetime warning of the drive power-on relay mounted on the GSK drive
Warning level	80 thousand times (lifespan 100 thousand times)
Determination method	It clears the relay operation count to 0 when manufacturing the GSK driver. The GSK controller increments this count by 1 each time the relay is moved. The GSK I / F checks the number of relay operations of each driver and it judges whether it exceeds the warning level or not.
Warning Reset	That is impossible.

Driver's EEPROM lifetime warning

Warning content	Lifetime warning of EEPROM rewriting installed in the GSK drive
Warning level	800 thousand times (lifespan 1 million times)
Determination method	It clears the EEPROM write count to 0 when manufacturing the GSK driver. The GSK driver increments this number by 1 each time EEPROM rewrite is performed. GSKIF checks the EEPROM write count of each driver and it judges whether it exceeds the warning level or not.
Warning Reset	That is impossible.

Interface battery warning

Warning content	Lifetime warning for batteries implemented in GSK-IF
Warning level	4 years (lifespan: 5 years)
Determination method	We write all 0 "00/0/0" as the battery replacement date at GSK-IF manufacture. We write the battery replacement date when connecting the battery to the GSK driver. GSK-IF compares the battery replacement date with the current date and it checks whether it exceeds the warning level or not. ※However, when the date of manufacture is all 0, it does not check.
Warning Reset	We set the battery replacement time by PC operation. * Since the date is likely to be out of order, we set the exchange time on the calendar IC of GSK-IF.

Driver amplifier battery warning

Warning content	Lifetime warning about battery installed in GSK driver
Warning level	1.5 years (2 years life)
Determination method	We write all 0 "00/0/0" as battery replacement date at GSK driver manufacture We write the battery replacement date from the PC when connecting the battery to the GSK driver. GSKIF compares the battery replacement date of driver with the current date to check whether it exceeds the warning level or not. ※However, when the date of manufacture is all 0, it does not check.
Warning Reset	We set the battery replacement time by PC operation.

13-5-4 Nut runner failure prediction warning

If any of the following warning conditions occur, the output signal "protection warning" will turn ON.

The warning level in the table is the initial value and can be changed by the personal computer.

When the warning level is 0, warning judgment is not performed

Driver overload warning

Warning content	The load current of the GSK driver exceeds a certain value.
Judgment target	Overload alarm level (percentage of alarm level)
Warning level	0%
Determination method	The GSK driver notifies the GSK I/F of the overload alarm level of the motor. GSK I/F checks whether the judgment value has exceeded the warning level and exceeded.
Warning Reset	Warnings can be reset by computer operation. It resets when turning off the power of GSK I/F.

Driver over regenerative warning

Warning content	The load current of the GSK driver exceeds a certain value.
Judgment target	Over regenerative alarm level (percentage of alarm level)
Warning level	0%
Determination method	The GSK driver notifies the GSK I/F of the over regenerative alarm level of the motor. GSK I/F checks whether the judgment value has exceeded the warning level and exceeded.
Warning Reset	Warnings can be reset by computer operation. It resets when turning off the power of GSK I/F.

13—6 Notes on input / output communication

1. Program selection

When selecting a program, the number to be selected must be within the range of 1 to the selected maximum value.
If the program number is 0 or more than the set maximum value, it will cause ALCO (program not selected NG).

2. Judgment reset

Judgment reset is not accepted except during general judgment output after program termination.
In order to prevent double tightening, a judgment reset input is always required after the program ends.
(general judgment output)

3. Inching start

Program selection is required to perform Inching start.
This operation is performed at the rotation speed and rotation direction of the SOC.T setting which number is same as the selected program number.
Do not enter inching start during program operation. It may cause a malfunction.

4. Alarm reset

Alarm reset input is valid only when an alarm occurs.

5. In signal

Effective only when IN is set in the program setting.
If IN setting is performed in the program, make sure to enter IN because the program waits for the input of IN after the program execution until the previous step before the IN is set.
Do not input the inching start and alarm reset. It may cause malfunction.

6. Auto/Each selection

Auto selection: Only the start input is accepted.
Do not turn OFF the start signal input until the total determination is output.
Doing so causes “FFFF” NG.
This is the interruption NG of the program while running.

Each selection: Only the inching start input is accepted.
When the input signal is turned OFF after inching started, it becomes to wait for the inching start and only operates when the inching star is turned ON.

7. GSK reset (ALL reset)

When GSK reset is input, make sure to input from the program selection because all steps return to the initial status.

8. Program bit selection

Program bit selection allows you to select the program number by combining the program bit.

9. Program setting

The program can set ratings and axis numbers for each block and each axis.

13-7 Precautions to read history

Make sure to give sufficient reading time to read the history data.

(In the case of communication speed at 19200 Bps, about 1 minutes of reading time is needed per axis.)

13-8 Items that can/cannot be set

Item	Manual input	Input from setup soft
Driver parameter internal setting	○	×
RATE. SET	○	○
SOC. T. SET	○	○
PRE. T. SET	○	○
REV. T. SET	○	○
REA. T. SET	○	○
AXIS ARRANGE SET	×	○
PROGRAM SET	×	○
AXIS CUT INPUT	○	○
ID OUTPUT SET	○	○
M-NETSTARTED ADDRESS	○	○

13-9 About connection setting of ID controller

13-9-1 Outline

Connecting the interface unit with ID controller by serial communication (RS422), transfer of engine number, setting of the calendar and transmission of result data become possible.

13-9-2 Specification of communication

Communication method : RS422
Communication speed : 9600bps
Start bit : 1
Stop bit : 1
Parity : non
Transmission start character : '#'(23H)
Transmission finish character : CR(0DH)
Transmission character : ASCII code

13-9-3 Respective format(PLC → Interface unit)

Respective of engine number.

[Engine number] CR Engine number should be maximum 7 figures by decimal numeral.

Data transmit demand or Specify of unit to send the data.

#U[n] CR Unit No. specified(n = 1 to 6)

Setting of calendar

#C [Calendar] CR Calendar setting (year, month, date, hour, minute each 2 figures)

13-9-4 Transmission format (Interface unit → PLC)

(1) Standard specification setting (1st figure = 1 of fn12 no.2)

[Date and time] [Judge] [Axis No.] [Program No.] [Unit No.] [Torque] [Time] [Angle] [Gradient] [Engine No.] CR

[Date and time] =01/12/29△15 : 59	(14letters)	△ means blank(20H)
[Each axis judgement] =0000(OK) or NG code	(4letters)	
[Axis no.] =01 to 30	(2 letters)	
[Program no.] =01 to 24	(2 letters)	
[Unit no.] =1 to 6	(1 letter)	
[Torque] =123.4	(Number of letters is according to the parameter)	
[Time] =12.34	(Number of letters is according to the parameter)	
[Gradient] =99.9	(Number of letters is according to the parameter)	
[Engine no.] =1234567	(Number of letters is according to the parameter)	

(2) Specification with Torque (1st figure = 1 of fn12 no.2)

[1st axis torque] [1st axis judgement] [2nd axis torque] [2nd axis judgement]
• • • [n axis torque] [n axis judgement] CR

[Each axis torque] =123.4	(Number of letters is according to the parameter)
[Each axis judgement] =2	(1=NG 2=OK)

(3) Specification without torque (fn1st figure = 3 of fn 12 no.2)

[1st axis torque] [1st axis judgement] [2nd axis torque] [2nd axis judgement]
• • • [n axis torque] [n axis judgement] CR

[Each axis torque] =△△△	(Number of letters is according to the parameter)△ means blank(20H)
[Each axis judgement] =2	(1=NG 2=OK)

Part of torque data always outputs zero.

(4) J specifications (fn1st figure = 4 of fn12 no.2)

[Date and time] [Program no.] [Unit no.] [Engine no.]
[Axis no.(01)] [1st axis torque] [1st axis time] [1st axis angle] [1st angle gradient] [1st axis judgement]
[Axis no.(02)] [2nd axis torque] [2nd axis time] • • • [n axis gradient] [n axis judgement] CR

[Date and time] = 01/12/29△15:59	(14 letters)△ means blank(20H)
[Program no.] =01 to 24	(2 letters)

[Unit no.] =1 to 6	(1 letter)
[Engine no.] =1234567	(Number of letters is according to the parameter)
[Axis no.] =01 to 30	(2 letters)
[Torque] =123.4	(Number of letters is according to the parameter)
[Time] =12.34	(Number of letters is according to the parameter)
[Gradient] =99.9	(Number of letters is according to the parameter)
[Each axis judgement] =0000(OK) or NG code	(4 letters)

13-9-5 Select with condition of starting transmission

It is possible to set timing of the transmission from the interface unit by the parameter.

Timing is able to be selected from one of follows;

- Data transmission at the time of the block judgement output
- Data transmission at the time of starting next block and judgement reset input.
- Data transmission according to the request of data transmission from the upper

13-9-6 Selecting transmission data

It is possible to set each data to be transmitted or not to be transmitted, specifying figure number, with or without decimal point to the parameter if necessary.

If there are some items which are not transmitted, the following items are transmitted shortening the items not to be transmitted.

Transmission of torque, time, angle data based on the kinds of operation

Transmission of torque data,time data and angle data, data of only one kind of operation is transmitted even if many kinds of operation such as pretightening, real tightening, etc. are carried out within the same block.

Selection with kinds of operation is effected automatically basing on the following order of priority.

When the operation with higher priority is not carried out, it select the operation of following order of priority.

In case of carrying out same kind of operation more than two times within the same block, the last operation is selected.

- | | |
|--------------------------|----------------------|
| Order of priority (high) | 1:Real tightening |
| | 2:Reverse tightening |
| | 3:Pretightening |
| (low) | 4:Socket fitting |

13–10 About setting

13–10–1 Installation

GSK-14, GSKW-14, GSK-T4 and GSKW-T4 have no difference about standard specifications and T specifications, so the installation method is the same.

Also, unlike other controllers, there is no additional action required for installation.

When installing all GSK units, install a cooler or fan so that the temperature inside the panel to be installed the units will be 50 ° C or less.

13–10–2 standard specifications

The standard specification controllers GSK-15, GSK-17, and GSKW-15 have fins or fans on the side for exhaust heat. Please install at least 10 mm apart between controllers for the exhaust heat of this fin or fan.

13–10–3 T specification

The controllers GSK-T5, GSK-T7 and GSKW-T5 of the T specification have fins for exhaust heat on the back.

A fan must be installed in the control panel to dissipate the heat from the fins.

Please confirm the contents of the following and install it.

About the air volume of the heat radiation fan

Heat dissipation requires an air flow of at least 0.6 m³ / min per controller.

If one fan is attached for two controllers, the air volume is more than double.

Moreover, in the case of 3 controllers, it is not recommended because the wind disperses.。

First, install the fan within 150 mm below the controller.

And please spray from bottom to top.

If the distance is 150 mm or more, please take measures such as increasing the air volume or preventing the wind from escaping.

Change log

Version	Data	Contents of change	Note
001	Apr.2019	—	—
002	Jun.2019	Output signal added <ul style="list-style-type: none"> • SD card warning • Driver ready • Warning Motor power cable specification clearly stated	IF Ver7010~
003	Sep.2019	6-1.Adding operations to explain 7-2.Adding parameters to be described 10-2-3. Changing the alarm description	
004	Sep.2019	3-5. Noise countermeasure added	
005	Jan.2020	E64 Added items of causes and countermeasures	
006	Jan.2020	Predictive maintenance function typo correction	
007	Mar.2023	Addition of overseas bases	
008	Mar.2024	Addition of E91 treatment method Corrected the parameter contents of d00141 Corrected NG code from 4 digits to 3 digits Added NG codes 271, 272, 471 and 472 2-1 Specifications of controller Modify dimensions Removal of ability to read and write settings using SD card 3-2-1GSK Used connector and mating connector Corrected wrong connector model	
009	Sep.2024	7-3 Added external signal stop to socket alignment setting 7-4 Added Average torque before seating, Angle A before stop torque, Angle B before stop torque total angle upper and lower limits to pre-tightening setting 7-6 Added total angle upper and lower limits to final tightening setting 10-1 Added 241 to NG code list	
010	Jan.2025	Correction of all items	
011	Feb.2025	Add target version to cover page	
012	Jul.2025	Addition of the REA.T setting <ul style="list-style-type: none"> • Added Torque mode for nutrunner with clutch and angle mode for nutrunner with clutch to tightening mode • Add return angle • Add Zero speed control time 	
013	Sep.2025	Specifications for Nut Runner Models ANZR-1600, ANZR-2000, and ANZR-3500 have been added.	
014	Jan.2026	Specifications for Nut Runner Model ANZMC-40SFFT-E3 Added Added soft stop start torque, soft stop time, and soft stop end torque to the final tightening setting.	
015	Apr.2026	Addition of the REA.T setting <ul style="list-style-type: none"> • Addition of continuous detection time for final tightening torque. 	

memo



■ HeadOffice

97-8, Imago-cho Yamatokoriyama, Nara, 639-1031

TEL : +81-743-59-3730

E-Mail (Sales engineering department) : gyomu@gikenkogyo.com

E-Mail (technical department) : seigyo@gikenkogyo.com

URL : <http://www.gikenkogyo.com>

■ Nagoya Branch Office

1202, Kumada, Nagakute, Aichi, 480-1144

TEL : +81-561-63-5321

E-Mail : nagoya@gikenkogyo.com

■ Kanto Branch Office

1-2-15, Matoba, Kawagoe-city, Saitama, 350-1101

TEL : +81-49-298-4755

E-Mail : kanto@gikenkogyo.com

Overseas base

■ Giken Sanko Engineering (Thailand) Co.,

798 Moo.7, T.Bangpoo Mhai

A.Muang Samutprakarn,

SAMUTPRAKARN

Thailand 10208

TEL : +66 0817556602